

Performance Simulation of Multicast for Small Conferences

Diplomarbeit
der Philosophisch-naturwissenschaftlichen Fakultät
der Universität Bern

vorgelegt von:
Stefan Egger

2002

Leiter der Arbeit:
Prof. Dr. Torsten Braun

Forschungsgruppe Rechnernetze und Verteilte Systeme (RVS)
Institut für Informatik und angewandte Mathematik

Abstract

Many new Internet applications require the transmission of data from a sender to multiple receivers. Unfortunately the IP Multicast technology used today suffers from scalability problems, especially when used for small and sparse groups. Multicast for Small Conferences is a novel approach aimed at providing more efficient support for audio conferences and other small group applications. This thesis contains a detailed explanation of the MSC concept and describes an implementation of MSC capable end systems and routers in the ns-2 network simulation software. Furthermore, a performance simulation based on real-world data is presented, including the analysis of several different combinations of MSC end systems and routers. The results of the simulations are discussed and condensed into conclusions highlighting the potential of Multicast for Small Conferences as a possible replacement of IP Multicast for small group applications.

Contents

1	Introduction	1
2	Scalable Multicast Schemes	3
2.1	Network-layer solutions	3
2.2	End system multicast	7
3	Multicast for Small Conferences	10
3.1	The MSC concept	10
3.2	MSC capable routers and end systems	10
3.2.1	End systems	10
3.2.2	MSC header handling for routers	12
3.3	Comparison with Xcast	14
3.4	Problems	14
3.5	Routing overhead	15
4	The Network Simulation Software: ns-2	16
4.1	Choosing a network simulator	16
4.2	Protocols, packet headers and packets in ns-2	17
4.3	Network components	17
4.4	Routing in ns-2	19
4.5	Unicast and multicast in ns-2	20
4.6	Tracing in ns-2	22
4.6.1	Ns-2 tracefiles	22
4.6.2	Nam	22
5	MSC Implementation in ns-2	24
5.1	Modifications and adaptations	24
5.2	The MSC protocol in ns-2	25
5.3	Implementing end system MSC in ns-2	26
5.3.1	The MSCAgent class	26
5.3.2	MSCAgent internals	26
5.3.3	Example	27
5.3.4	The NaiveAgent class	29
5.4	Implementing MSC capable routers	30
5.4.1	The MSCRouter class	30
5.4.2	MSCRouter internals	30
5.4.3	Example	31
5.4.4	The EMSCRouter class	32

Contents

5.4.5	EMSCRouter internals	32
5.4.6	Example	32
5.5	MSC component tracing features	34
5.6	Running MSC simulations	36
6	Simulation Topology	38
6.1	Introduction	38
6.2	Backbone networks	38
6.3	End systems	39
6.4	Real-world data and ns-2	40
7	Simulation Setup	45
7.1	Simulation parameters	45
7.1.1	Group size	45
7.1.2	Clustering	45
7.1.3	MSC router functionality	46
7.2	Packets	48
7.3	Metrics	50
8	Results	51
8.1	Average delays	51
8.2	Maximum delays	51
8.3	Bandwidth consumption	53
8.4	Backbone usage	54
8.5	Summary	57
9	Performance Evaluation	59
9.1	Native multicast	59
9.2	Naive unicast	59
9.3	End system MSC	60
9.4	Full-scale MSC	60
9.5	MSC at backbone interlinks	61
9.6	EMSC at backbone interlinks	61
9.7	MSC SIX	62
9.8	EMSC SIX	62
9.9	Comparison of MSC and native multicast	63
10	Summary	64
11	Outlook	66
	Glossary	67
	Bibliography	69

1 Introduction

The increasing popularity of the Internet in the last few years not only led to a massive increase in the number of users, but also pushed the development of many new technologies which in turn widen the range of applications available. Most of the widely-used traditional Internet applications, such as web browsers and email, operate between one sender and one receiver, i.e. they use *unicast* (point-to-point) connections. However, many new applications require one or more sources to synchronously serve multiple receivers. Examples are the communication of stock quotes to brokers and audio (or video) conferencing. Naively, this could be implemented as a number of unicast connections maintained between the source(s) and the receivers. However, this is a very inefficient approach: a sender transmitting to a group of ten receivers would have to transmit the same data ten times. This puts needless strain on the network infrastructure and consumes a lot of precious bandwidth. Also, such a configuration requires the sender to keep track of receivers as they join or leave a session. Unsurprisingly, a more efficient technology has already been developed: IP Multicast. In IP Multicast, each session (i.e. each group of senders and receivers) is identified by a multicast group address, and traffic is delivered to all members by the network infrastructure. The sender does not need to maintain a list of receivers, as the receivers can join and leave multicast groups at their discretion. Also, a host may be a member of more than one group at a time and does not need to be a member of a group to send datagrams to it. The network infrastructure, in particular the routers, are responsible that a transmission reaches all group members. In order to do that, each router maintains routing table entries for all multicast groups affecting it. The routers also make sure that only one copy of a multicast message will pass over any link in the network, and copies of the message will be made only where paths diverge at a router. There are two kinds of groups: permanent and transient. Permanent groups have a well-known, administratively assigned IP address. Those multicast addresses that are not reserved for permanent groups are available for dynamic assignments to transient groups which exist only as long as they have members [18, 10].

As the Internet more and more replaces traditional telecommunication networks, it seems very promising to also use IP Multicast to simplify audio conferencing, which is complex to set up and very inefficient regarding bandwidth usage when conventional technology is used. To support a conference, the IP terminals and gateways serving the conferencing participants can join a common multicast group and exchange traffic via IP Multicast. This avoids the multiple transport of the same traffic over the backbone networks that is seen in traditional telephone conferences based on Multipoint Control Units (MCUs).

Unfortunately, IP Multicast does not scale well for (many) small groups such as in audio conference scenarios. The problem is that the multicast routing entries within routers cannot be aggregated such as unicast routing entries. While leading unicast address prefixes can be used for routing entry aggregation, multicast address selection can be arbitrary so that multicast addresses with similar prefixes do not necessarily have any relation to each other

such as common multicast delivery trees. The scalability problem is even worse since multicast routing entries do not only consist of the destination address but may even include a source address. This means that a backbone router needs to maintain a multicast routing entry for each global multicast address (or each <source address, multicast address> pair even if this multicast group consists of a few members only [6]. As new small group applications are becoming more and more popular, the routing table sizes are increasing massively. This not only makes routers more expensive (given the high prices of router memory), but also deteriorates the performance of these devices. Hence it is not surprising that several proposals addressing this problem have arisen recently [30, 29]. There are basically two different approaches: One idea is to move the multicast functionality up to the application layer, simplifying the underlying network. Other concepts favor network-layer solutions enhancing or replacing IP Multicast.

This document introduces both approaches: In the first part of chapter 2, Explicit Multicast (Xcast), Recursive Unicast Tree Multicast (REUNITE), Explicitly Requested Single-source Multicast (EXPRESS), Distributed Core Multicast (DCM) and the Host Multicast Tree Protocol (HMTP) are presented; all five are network-layer solutions. Multicast concepts using the application layer are presented in section 2.2. These include three infrastructure-reliant approaches (CANs, Scattercast, Bayeux), plus Narada. As the title suggests this thesis focuses on MSC - explained in detail in chapter 3 - and presents a performance study based on simulation results. Consequently, chapter 4 provides an introduction to the ns-2 network simulator and its most important features, while chapter 5 gives an in-depth explanation of an MSC implementation in ns-2. In the subsequent two chapters (6 and 7), the simulation topology and the simulation setup are presented. The simulation results are discussed on a per-parameter basis in chapter 8, while the performance of the different configurations is discussed in chapter 9. Chapter 10 presents a number of conclusions based on the simulation results, with the final chapter providing a short description of possible future work. This is followed by a glossary and the bibliography at the end of the document.

2 Scalable Multicast Schemes

This chapter presents several concepts proposed as alternatives to or extensions of IP Multicast, mainly for small group applications. It describes five network layer concepts (Xcast, REUNITE, EXPRESS, DCM and HMTP) and four application level multicast approaches. The latter group includes three infra-structure reliant methods (CANs, Scattercast, Bayeux) and one “real” end systems concept (Narada).

2.1 Network-layer solutions

All of the following approaches propose multicast implementations on the network layer. They either define an all-new protocol or extend the existing IP Multicast mechanism.

Explicit Multicast (Xcast)

Explicit Multicast [31] (the successor of Small Group Multicast [5, 4]) is a multicast scheme designed for supporting a very large number of multicast sessions as present in audio/video conferencing, network games or collaborative working. It differs from native multicast in that the sending node keeps track of all session members and explicitly encodes the list of destinations in a special packet header. This newly defined header introduces a new protocol between the network (IP) and the transport (UDP/TCP) layer. Xcast capable routers that receive such a packet parse the Xcast header and use the ordinary unicast routing table to determine how to route the packet to each destination, generating a packet copy for every affected outgoing interface. Each address list contains only the addresses that can be reached via that interface. If there is only one destination for a particular next hop, the packet may be sent as a standard unicast packet, as there is no multicast gain by formatting it as an Xcast packet.

The Explicit Multicast scheme has three major advantages:

- Routers do not have to maintain per session state. This makes Xcast very scalable in terms of the number of sessions that can be supported since the nodes in the network do not need to disseminate or store any multicast routing information for these sessions.
- No multicast addresses are used; thus, all problems related to multicast address allocation are eliminated.
- No multicast routing protocols are required, neither intra- nor interdomain. Xcast packets always take the correct path as determined by the unicast routing protocols.

But while Xcast solves the scalability problems of native multicast, it creates some new complexity:

but does not branch at the router. This is not equivalent to the concept of native multicast, since an MCT lookup is only necessary when processing control messages; during normal packet forwarding, only MFT lookups need to be performed. REUNITE has a number of advantages over IP Multicast:

- Only the routers at branching points are required to keep multicast forwarding state of the group. In effect, REUNITE removes unnecessary forwarding state by converting it into control path state. This results in enhanced scalability, especially in large networks with many small groups.
- REUNITE is incrementally deployable. Since all packets have unicast addresses, a router that does not implement the new protocol just forwards the packets as if they were unicast packets.
- Since REUNITE does not require every router to process protocol control messages, a router that is overloaded can decline making further MFT entries and let other upstream routers process the relevant messages. This results in a load balancing capability (even though the forwarding tree may become less efficient).

Using REUNITE gateways, it is possible to retain native multicast in local networks. Since REUNITE does not use class D addresses at all, the gateways may even use different IP multicast addresses in their respective local networks.

The performance evaluation of REUNITE presented in [27] is based on several ns-2 simulations (ns-2 is presented in chapter 4). However, only the link stress (i.e. the number of identical packets sent over a link) has been analysed. With many REUNITE capable routers in the network, the value is very low (close to one). In contrast, link stress values of up to 12 were observed in scenarios with up to 64 receivers and no REUNITE routers.

Explicitly Requested Single-Source Multicast (EXPRESS)

In contrast to Xcast and REUNITE, EXPRESS [15] does not want replace IP multicast. Instead, it provides an extension which introduces means for access control and charging mechanisms. EXPRESS uses the concept of multicast channels. A channel is a datagram delivery service identified by the sender's source address and a channel destination address. These destination addresses are specially allocated class D addresses and allow each host in the Internet to source up to 16 million channels (since a session is identified by the source *and* the channel ID). This is an advantage over IP multicast, where address allocation has to be coordinated Internet-wide.

EXPRESS also introduces a new service function called *count*, which can be used to collect information such as the number of receivers a channel serves or the number of links in the delivery tree. This type of information is useful for charging models.

In terms of packet forwarding, EXPRESS behaves like conventional IP Multicast. ECMP, the management protocol of EXPRESS, sets up forwarding entries in the routers forwarding tables like other multicast protocols do. Therefore, the problem of increasing routing table sizes is not addressed.

Distributed Core Multicast (DCM)

The Distributed Core Multicast [3] routing protocol differs from the previously presented approaches in that it replaces IP Multicast in the backbone networks but retains native multicast for delivery in the access networks. It has been specifically designed to scale better than existing multicast routing protocols when there are many multicast groups with only a few members each. DCM relies on an overlay network created by so-called Distributed Core Routers (DCRs). The DCRs are located at the edge of the backbone networks and act as access points for data from senders inside their area (i.e. an access network) to receivers outside this area. Multicast packets from senders inside are sent towards the local DCR either by encapsulation or source routing. A DCR also forwards the multicast data received from the backbone to receivers in the area it belongs to, using native multicast. The Membership Distribution Protocol (MDP) runs between the DCRs serving the same range of multicast addresses and allows the DCRs to learn about other DCRs that have group members. Also, the Distributed Core Routers run a special data distribution protocol that tries to optimize the use of backbone bandwidth and does not require the non-DCR backbone routers to perform multicast routing. The performance evaluation of DCM presented in [3] is based on ns-2 (see chapter 4) simulations. It indicates that DCM can massively reduce the routing table size for backbone routers, as they only need to maintain membership information for a small number of MDP control multicast groups. Also, the DCRs' routing tables are significantly smaller than those of a backbone router when using PIM-SM¹.

Host Multicast Tree Protocol (HMTP)

While the advantages of multicast delivery over unicast delivery are undeniable, the deployment of the IP Multicast protocol has been limited to "islands" of network domains under single administrative control. These islands need to be connected by manually configured tunnels to form a static overlay network, which is expensive to set up and maintain. The goal of Host Multicast [32] is to dynamically connect IP Multicast islands using UDP tunnels. To achieve this, one member host in each island is elected as the Designated Member (DM) for the island. Each DM runs the Host Multicast Tree Protocol (HMTP), which allows the DMs to self-organize into a bi-directional shared tree. Multicast packets produced by sender inside an IP Multicast island are intercepted by the Designated Member hosts, encapsulated into UDP packets and forwarded along the tree. Receiving DMs decapsulate the packet and multicast them in their respective local domains.

Host Multicast has two major advantages:

- It is fully deployable in the current internet, since it does not depend on cooperation from routers, servers, tunnel end-points and operating systems.
- It takes advantage of IP Multicast's scalability (in terms of bandwidth consumption), since it automatically uses IP Multicast where available.

While HMTP helps the development and deployment of IP Multicast, it does not address any of the latter's problems mentioned in chapter 1.

¹Protocol Independent Multicast - Sparse Mode

2.2 End system multicast

While the concepts presented in the previous sections try to overcome the problems of IP Multicast by improving the network layer with new router functionality and/or new protocols, there is also a different approach: end system multicast. The idea is to migrate the multicast service to higher levels, thereby simplifying the underlying network model. Thus, the problems that plague IP Multicast (group management, routing) are either eliminated or mitigated due to application-level intelligence. However, the key concern with such a model is the associated performance penalty. In particular, an overlay approach to multicast, however efficient, cannot perform as well as IP Multicast. It is impossible to completely prevent multiple overlay edges from traversing the same physical link and thus some redundant traffic on physical links is unavoidable. Further, communication between end systems involves traversing other end systems, potentially increasing latency [16].

A number of end system/application-level multicast concepts as well as their respective performance characteristics are presented in the following sections. The CAN, Scattercast and Bayeux approaches are infra-structure-reliant in the sense that they use an overlay network not only consisting of the end systems in a specific multicast group, but requiring some permanently deployed, group-independent functionality in the network (e.g. a certain router feature or routing protocol). In contrast, the Narada concept is a “real” end system multicast approach, using only the end systems that are members of a certain multicast group for transmissions for that group.

Content-Addressable Networks (CAN)

A Content-Addressable Network [23] is a self-organizing application-level network whose constituent nodes can be thought of as forming a virtual d -dimensional Cartesian coordinate space. Every node in a CAN “owns” a portion of the total space. CANs are scalable, fault-tolerant and completely distributed. The authors of Application-level multicast using CANs [24] argue that

- assuming the deployment of a CAN-like infrastructure in the network, CAN-based multicast is trivially simple to achieve.
- CAN-based multicast can scale to very large group sizes without restricting the service model to a single-source.
- no multicast routing protocol is required, since routing is inherent in CANs.

The simulation-based performance evaluation of multicast using CANs presented [24] indicates that with physical (IP-level) delays of up to 100ms the actual delay in the application-level network can easily reach 300ms, with single values up to 600ms. Thus, it is unlikely that this approach could be used for delay-sensitive applications such as audio or video conferences. However, multicast using CANs could be ideal for less demanding services that need to support very large group sizes.

Scattercast

Scattercast [7], also an application-level approach, relies on a collection of strategically placed network agents (ScatterCast proXies, SCX) that collaboratively provide the multicast service

for a session. Agents organize themselves into an overlay network of unicast connections and build data distribution trees on top of this overlay structure. Clients locate a nearby agent and tap into the multicast session via that agent. Native multicast mechanisms are used for communication between the client(s) and the proxies, while the proxies exchange data using unicast connections and a special protocol called Gossamer.

The simulations performed by the authors of Scattercast show that the end-to-end delays are 1.35-2.35 those of native unicast, with a typical value of 1.65. This cost ratio increases when more SCXs are introduced (due to the additional overhead), but it remains well below 2 even with 350 SCX involved. This should make Scattercast suitable for many applications. Also, the Gossamer protocol used for SCX interaction significantly reduces the link stress (the number of duplicate packets sent over a link) compared to naive unicast, where one packet copy per receiver is created. However, bandwidth consumption has not been analyzed.

Bayeux

Bayeux [34] uses a prefix-based routing scheme that it inherits from an existing application-level routing protocol called Tapestry [33], a wide-area location and routing architecture. On top of Tapestry, Bayeux provides a simple protocol that organizes the multicast receivers into a distribution tree rooted at the source. Tapestry itself guarantees good scalability and provides multiple paths to every destination, thus enabling application-specific protocols for fast failover and recovery. Unlike most other application-level multicast systems, not all nodes of the Tapestry overlay network are Bayeux multicast receivers. This use of dedicated infrastructure server nodes provides better optimization of the multicast tree.

The performance evaluation presented by the authors uses a topology of 50'000 nodes and simulated multicast groups with 4'096 members. The results show that the end-to-end delays increase by a factor of up to 6; this indicates that Bayeux cannot support delay-sensitive applications such as audio or video conferences (unless the underlying physical network has a very low latency). The advantages of Bayeux are the support for very large groups and its fault-handling, the latter also allowing reliable service, a feature unique to Bayeux.

Narada

Narada [16] is a "real" end system multicast protocol in the sense that it does not require any infrastructure support (i.e. pre-deployed network functionality). It constructs an overlay structure among participating end systems in a self-organizing and fully distributed manner. The construction of the overlay is performed in a two-step process. First, an arbitrary connected subgraph of the Complete Virtual Graph (CVG) is created. In a second step, Narada constructs reverse shortest path spanning trees of the mesh, each tree rooted at the corresponding source; this is done using well-known algorithms. Since the overlay construction mechanism of Narada is self-organizing and self-improving, Narada is robust to the failure of end systems and to dynamic changes of group membership. Unlike Xcast and MSC, Narada can also support large multicast groups. This is confirmed by the performance evaluation presented in [16], which is based on simulations with topologies of up to 1'070 nodes and multicast groups of up to 256 members. In a group with 128 members, the delay between 90% of pairs of members increases by a factor of at most 4 compared to the unicast delay between them. For a group of 13 members the same value is 1.5. Thus, Narada seems to be a viable solution for supporting small multicast groups. In terms of bandwidth con-

2 Scalable Multicast Schemes

sumption, Narada performs significantly worse than native multicast. For the previously mentioned 128-member group, Narada consumes 80% more bandwidth than IP Multicast. However, this is about a 20% saving compared to naive unicast. With larger group size, the performance of Narada relative to native multicast improves. Also, link stress (i.e. the number of identical packets sent over a link) is massively lower with Narada than with naive unicast.

Unfortunately the data of the performance evaluation of Narada presented in [16] is not directly comparable to the data of the MSC simulations performed as part of this thesis. Narada was developed to replace native multicast for a wide range of applications and can also support large groups. Consequently, the performance evaluation has been performed with very large simulation topologies (up to 1'070 nodes) and different multicast group sizes, ranging from 13 to 256 members. In contrast, Multicast for Small Conferences only is an alternative to native multicast in (very) small groups. Thus, the performance simulations presented in chapter 7 are run with groups of 4 to 20 hosts only. Also, a completely different topology is used. The NRU (Normalized Resource Usage) values of the two simulations can be used to illustrate their incompatibility. While the Narada simulations have a maximum NRU of 2.1 for naive unicast, the same value is 3.7 in the MSC simulations, despite massively smaller group sizes, which should result in less packet copies.

3 Multicast for Small Conferences

This chapter contains an in-depth description of the Multicast for Small Conferences concept and explains the functionality of MSC end systems and routers. Also included are a comparison between MSC and Xcast as well as a short discussion of possible problems affecting Multicast for Small Conferences. The last section covers the aspect of increased routing complexity.

3.1 The MSC concept

The Multicast for Small Conferences [6] concept aims at solving the scalability problem of native multicast while at the same time avoiding the problems of an Xcast-like approach. A first difference is that MSC is proposed as a concept for multicast packet delivery in the Internet backbone only, while existing intra-domain multicast routing mechanism can remain in use for regional or access networks. Also, instead of introducing a new protocol, MSC relies solely on the existing IPv6 [26] protocol, in particular on the IPv6 routing header. In the Multicast for Small Conferences concept, the unicast address of each receiver is stored in each packet. The address of the receiver closest to the sender is used as the IP destination address, while the other addresses are carried in the routing header. The group's multicast address should ideally be stored in the routing header as well. However, according to the IPv6 specification [26], multicast addresses must not appear in a routing header of type 0, or in the IPv6 destination address field of a packet carrying a routing header of type 0. There are two solutions to overcome this limitation. The first solution is compatible with all current IPv6 routers, while the second solution is recommended for long-term usage. While in the first solution the multicast address is carried in a newly defined IPv6 destination option, in the second solution it is carried at the end of an also newly defined type 1 IPv6 routing header.

3.2 MSC capable routers and end systems

3.2.1 End systems

MSC sender

An MSC routing header is generated by a sender that is either an MSC terminal or an MSC gateway. The MSC gateways have the task of supporting end systems not capable of MSC and/or IPv6 by “translating” the transmission, using native multicast in the local network. In any case the sender creates a unicast address list of all group members and puts the nearest one in the IPv6 destination address. All other member addresses are put into the MSC routing header, preferably ordered by the distance from the sender. If the sender detects

that members have to be reached via different outgoing interfaces, a packet for each affected interface is generated with the list of members that can be reached via this interface. This means that a sender divides the address list into N parts and sends N copies of the packet to the N generated lists.

The example in Figure 3.1 shows a topology with five routers (R1-R5), a single sender (S) and four receivers (D1-D4). When transmitting a packet, S puts all receiver addresses in the packet.

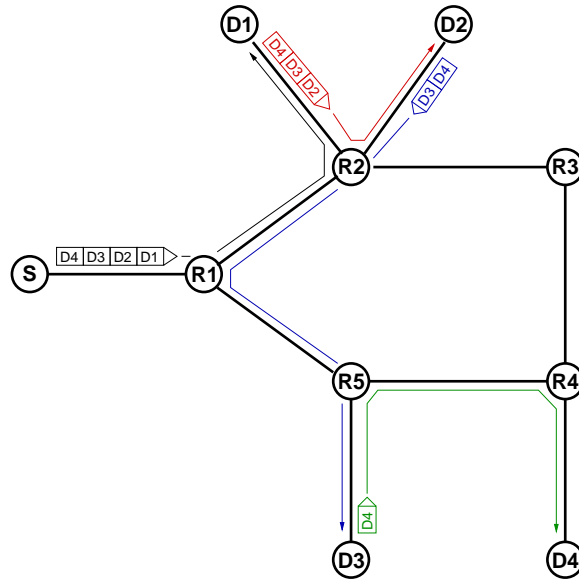

Figure 3.1: End system MSC

Receiving end systems

A receiving end system which finds its address in the address list creates a packet for the higher protocols encapsulated in the IPv6 packet by copying the multicast address found in the new destination option into the IPv6 destination address and by removing the routing header. This packet is delivered to the higher protocol for further processing. An MSC gateway forwards the packet to local multicast receivers using the appropriate scope.

If the routing header contained further unicast addresses, a new packet is generated with the address of the nearest node in the IPv6 destination address. As before, a routing header carries the remaining unicast addresses. The packet is forwarded via the outgoing interface of the end system. A multi-homed system might also generate several copies of the packet if it can reach nodes of the address list via different outgoing interfaces. In this case, the receiving end system behaves like the sender of the packet or an MSC capable router.

In the example in Figure 3.1, the concept of MSC packet forwarding between receiving is illustrated. D1 is the first end system to receive the packet transmitted by S. Detecting that additional addresses are carried in the routing header, D2 creates a new packet copy addressed to D2; the remaining addresses are again carried in the routing header. D2 and D3 perform similarly, forwarding the packet to D2 and D3 respectively. Arriving at D4, the

packet's routing header is empty (apart from the group's multicast address), and thus no packet forwarding is required from the part of D4.

3.2.2 MSC header handling for routers

Non-MSK routers

A router that does not understand the MSC header forwards the packet towards the address specified in the IPv6 destination field.

MSK capable routers

MSK capable routers read the addresses from the IP destination field and the routing header and determine the outgoing interface for each destination. They then duplicate the packet for each involved link. Each packet contains only the unicast addresses that can be reached via that interface plus the multicast address identifying the group. This is the MSC functionality proposed in [6]; in this document, this concept is denoted *standard MSC*.

Figure 3.2 illustrates the standard MSC procedure for routers. The setup is the same as in Figure 3.1, with S sending a packet to the group members D1-D4. All five routers (R1-R5) are considered MSC capable. On receiving the packet sent by S, R1 performs routing table lookups for all four addresses carried therein, detecting that D1 and D2 are reached via R2, while the other two receivers are reached via R5. Thus, R1 produces two packet copies, each one containing only the relevant addresses. R2 and R5 perform the same operation on the packets they receive, thus optimizing the packet delivery. In this scenario, no packet forwarding between end systems is necessary. If, for example, R2 had not been MSC capable, then the packet created by R1 would have been delivered to R3, which would have forwarded it to D4 as shown in Figure 3.1.

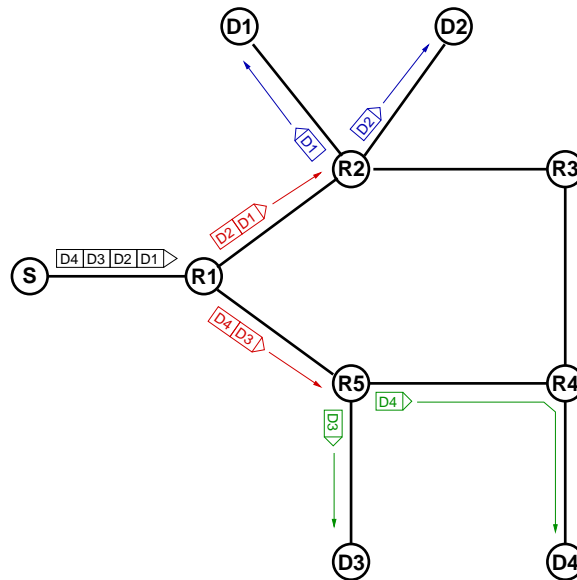

Figure 3.2: Standard MSC

Enhanced MSC

A possible improvement of the standard MSC concept involves the use of topology information, which can for example be obtained from a link state routing protocol such as OSPF.

¹ The first MSC capable router that handles an MSC packet after it enters a certain network domain determines the egress router (i.e. the router where the packet leaves the domain) for the destination address and all addresses listed in the routing header. A packet is then created for each involved egress router. Thus, packet forwarding between destinations connected to the same network can be eliminated. On the downside, multiple MSC packets may be sent over the same link, if two or more egress routers are reached via the same outgoing interface. In this document, this advanced concept is denoted *enhanced MSC*.

Figure 3.3 illustrates packet forwarding using enhanced MSC. The topology is the same as that of the previous two figures. Again, all five routers are considered MSC capable; additionally, we assume that R1-R5 form a network domain. As R1 receives the packet sent by S, it determines the egress router for all addresses: R2 for D1 and D2, R5 for D3 and R4 for D4. Thus, three packet copies are created, each carrying only the addresses reached via a certain egress router. R4 and R5 do not need to perform any special action, as the packets they encounter only carry a single address. However, in contrast to the standard MSC concept, two packets with identical payload were sent over the R1→R5 link. R2 detects that D1 and D2 are reached via different interfaces and creates a packet copy for each receiver. This part of the MSC functionality is identical in standard and enhanced MSC.

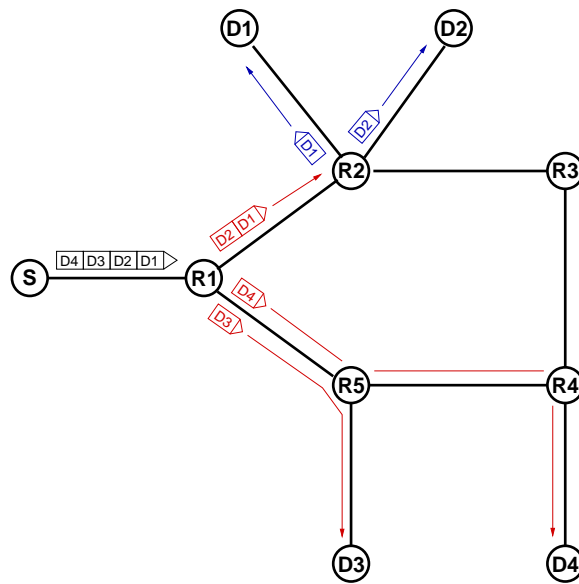

Figure 3.3: Enhanced MSC

¹Open Shortest Path First

3.3 Comparison with Xcast

Although MSC is based on ideas similar to XCast, there are significant differences:

- MSC avoids introducing a new protocol and instead relies solely on IPv6.
- MSC requires no tunneling between gateways, as routers without MSC functionality can simply forward the packet according to the IPv6 destination address. This also simplifies a gradual deployment of MSC in the network.
- MSC uses unicast forwarding in the backbone; multicast routing can be retained in local networks using MSC gateways.
- MSC allows applications to use native IP Multicast. Gateways only need to insert an MSC routing header instead of doing complete address mapping as in Xcast. Therefore the same multicast address can be used at different sites without the need for synchronizing the gateways.

These items are an indication that Multicast for Small Conferences is less complex to introduce and use than Explicit Multicast.

3.4 Problems

Multicast for Small Conferences suffers from the following problems [6]:

- The IPv6 routing header creates overhead that is increasing with the group size. This might be a problem for audio applications, where the packets are usually relatively short. Severe complications might emerge in wireless networks. The overhead problem can be solved by gateways serving as MSC receivers and forwarding the received packets via native IPv6 Multicast to the other receivers after discarding the routing header.
- MSC is an IPv6 only solution and requires the MSC routers and gateways to support IPv6; solutions such as IP options have to be found to support IPv4 end systems.
- All senders need to know the IPv6 unicast address of the group members. This problem can be solved by a group control protocol by which the MSC receivers announce conference group membership to each other. This information might be distributed within session descriptions of the Session Announcement Protocol (SAP) by which session descriptions are distributed over a well-known multicast address. The integration of SDP and MSC is discussed in [6].
- MSC introduces additional complexity to the routing process, an aspect which is discussed in the next section.

The problem of increased bandwidth consumption due to the routing header is discussed as part of the performance evaluation in chapter 9.

3.5 Routing overhead

As pointed out in the introduction, native multicast is not suitable for supporting a large number of small multicast groups. The reason is that each router that is part of a forwarding tree has one or more routing table entries for each multicast group. This increases the routing table size, since the multicast addresses cannot be aggregated. Multicast for Small Conferences and other approaches exonerate the routers by explicitly carrying the receiver's unicast addresses in each packet, which eliminates the need for routers to maintain any information about multicast groups. While this reduces the routing table size, it increases the complexity of the routing process: When handling an IP Multicast packet, the router has to scan the routing table for all entries with that address (determining the affected outgoing interfaces) and produce the appropriate number of packet copies. But when encountering an MSC (or Xcast) packet, the router has to perform multiple lookups, one for each unicast address carried in the packet. Furthermore, the router cannot simply create a packet copy per outgoing interface. Instead, it has to make sure that each packet only contains the addresses that can be reached via a certain interface, i.e. the router has to modify the routing header. While the additional routing table lookups should only marginally affect the router's overall performance, the additional header handling and packet copying may be more problematic, even though the address/interface sorting mechanism is relatively simple to implement [2]. However, MSC and Xcast will in any case put less strain on the router than a naive unicast approach would.

4 The Network Simulation Software: ns-2

Chapter 4 gives an insight into the network simulation software used for this project. It consists of an overview of ns-2's capabilities as well as descriptions of some specific features that were relevant for the implementation of MSC. The latter category includes aspects such as protocols, packets and packet headers, end system simulation as well as unicast and multicast routing mechanisms.

4.1 Choosing a network simulator

There are quite a number of network simulators available today. However, not all of these have been able to establish a good reputation within the research community, and of those who have, most are expensive (e.g. Opnet [21]). In contrast, ns-2 is freely available, and this has certainly been one of the reasons why it has become the de facto standard network simulator for academic research. The software package, developed by the Information Sciences Institute (ISI) of the University of Southern California (USC) as part of the Virtual Internet Testbed (VINT) [19] since 1995, has some major advantages:

documentation Ns-2 has an extensive user manual (~350 pages) which is maintained by the developers and updated regularly. Furthermore, there are a number of tutorials available for new users [14, 8].

large number of users Since ns-2 is widely used in academic research there are a lot of people working on and with the simulator worldwide. Their knowledge is brought together and shared through a mailing list with a huge searchable archive.

specialized modules Ns-2 supports the simulation of a large number of technologies and procedures, including LANs, mobile networking, satellite networking and ad-hoc networking.

Unfortunately, ns-2 also has a number of deficiencies:

mixed coding in OTcl/C++ The developers of ns-2 tried to achieve a fast iteration time while at the same maintaining a good run-time performance. The result was the use of a combined OTcl/C++ framework. This in fact yields the envisaged result, but on the downside the simulator source code tends to be complicated and difficult to understand.

documentation As mentioned above, ns-2 has an extensive documentation covering almost all aspects of the simulator. But despite being updated regularly the documentation is not up to date in all parts, which complicates things for developers. Furthermore, there are very few comments in the code, making program analysis even more difficult.

structure The structure of ns-2 isn't logical in all parts. While there are components like packets, links and queues, there is no such thing as a router. Instead, the router functionality is implemented in a number of internal components (see section 5.4 for details), which makes changes to ns-2's routing mechanisms rather difficult.

Overall, it can be said that ns-2 is relatively easy to use as long as existing modules can be used. However, the development of new components is rather complex and time-consuming. This is particularly true for the implementation of functionality inside the network (e.g. routers).

4.2 Protocols, packet headers and packets in ns-2

When talking about packets in ns-2, it is important to distinguish between the packet that is simulated (i.e. a real-world packet) and the simulator's internal packet representation. The difference can easily be illustrated by looking at a packet at network level, for example from an audio transmission. In reality, such a packet could consist of an IP header, followed by UDP and RTP headers and the payload (the actual audio data). In the simulator, the packet has these four parts as well, but it also features *all* other packet (or protocol) headers which ns-2 supports, e.g. TCP, Ping, MAC etc, even though they're not all used. Also, each ns-2 packet has a so-called common header, which contains important simulator information such as the simulated packet size (in the example: length of IP, UDP and RTP headers plus payload length), the packet type, a unique packet ID assigned by the simulator and a timestamp field used to measure queueing delays.

Furthermore, ns-2's packet headers for specific protocols do not necessarily correspond to the protocol headers defined in RFCs. For example, ns-2's IPv4 header just consists of the destination address, the source address and a TTL field. Everything else (such as ToS, header checksum, options etc.) has been left out. However, additional fields may be added to any header if the need arises.

Since ns-2.1b8 - the version used for the simulations in this thesis - does not explicitly support IPv6 and in particular does not provide the means for supporting a routing header, an MSC packet header was introduced to simulate the relevant fields as well as to store additional information needed for the simulation (original sender, sending time). This new header structure will be described in detail in section 5.2.

4.3 Network components

In ns-2, a simulation is set up by creating a network out of components provided by the software. There are three major components: Nodes, Links and Agents. Nodes represent hosts or routers in a network. By connecting Nodes with Links, a network topology is formed. Agents represent endpoints where network-layer packets are constructed or consumed; they are also used for the implementation of protocols at various layers. ns-2 has a variety of Agents for different protocols. Some Agents are both sender and receiver, while others are specialized on a single function. For the simulation of MSC capable end systems a new ns-2 Agent has been developed; it is described in section 5.3. Agents are attached to Nodes and identified by an address consisting of the Node's ID and a port number. A Node can be connected to one or more Links and host zero or more Agents. During a simulation, packets

are forwarded through the network by each component passing it on to the next, e.g. Agent to Node, Node to Link etc.

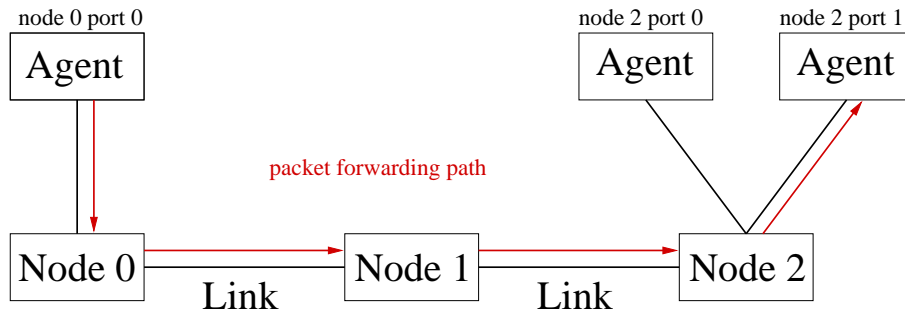

Figure 4.1: Ns-2 network components

The following Tcl script illustrates the use of Nodes, Links and Agents:

```
# simple agent demo

set ns [new Simulator]

# open nam trace file
set nf [open out.nam w]
$ns namtrace-all $nf

# open ns trace file
set tracefile [open trace.ns w]
$ns trace-all $tracefile

set n0 [$ns node]
set n1 [$ns node]
set n2 [$ns node]

$ns duplex-link $n0 $n1 1Mb 10ms DropTail
$ns duplex-link $n1 $n2 1Mb 10ms DropTail

set udp0 [new Agent/UDP]
set null2a [new Agent/Null]
set null2b [new Agent/Null]

$ns attach-agent $n0 $udp0
$ns attach-agent $n2 $null2a
$ns attach-agent $n2 $null2b

$ns connect $udp0 $null2b

$ns at 0.1 "$udp0 send 100"

$ns run
```

This code creates the network shown in Figure 4.1. Three Nodes are created and connected by two 1 Mbit links. Node 0 hosts an Agent used for the simulation of the UDP transport

protocol, while Node 1 does not have any Agents, i.e. it is acting as a router only. Two NullAgents are attached to Node 2. Attached to ports 0 and 1 respectively they both act as traffic sinks, as they simply discard any incoming packets. The simulator schedules a “send” event for the UDP Agent for simulation time 0.1. Thus, at this time the UDP Agent will send a data packet addressed to Node 2 Port 1. The results of this simulation are shown in Figure 4.2.



Figure 4.2: Nam output for the script listed above. (More information about Nam is provided in section 4.6.2.) The UDP protocol Agent on Node 0 sends a packet addressed to one of the Agents on Node 2. This packet is forwarded by the Node and Link components to the receiver, which discards it.

4.4 Routing in ns-2

Unfortunately, there’s no such thing as a router in ns-2. Instead, router functionality is implemented in different parts of the node. The routing tables are maintained by a routing object in the Simulator (class `RouteLogic`) and, in case of dynamic routing, in the Nodes (class `rtObject`). Furthermore, there are routing agents which implement the different routing protocols supported by the simulation software.

Inside the Node, packet forwarding is performed by classifier objects (described in chapter 5 of the ns Manual [20]). Classifiers are components with a single entry for packets and one or more outputs. They analyse incoming packets and pass them on to the next downstream object, which can be another classifier, a link or an agent (Figures 4.3 and 4.4).

NS-2 provides several types of classifiers:

Address classifiers examine a packets destination field and are used primarily for unicast packet forwarding. The **Port classifier** is also an address classifier; it is used for forwarding a packet to the correct receiving Agent on a Node.

Multicast classifiers are installed at the nodes if a simulation uses multicast. These components basically have the same functionality as address classifiers, forwarding packets according to their source and destination addresses. However, they use Replicator objects to forward multiple packet copies if necessary.

Replicators are special classifiers since they do not analyse the packets: A Replicator just sends copies of a packet to all outputs.

Multipath classifiers do not examine any packet fields. Incoming packets are forwarded to the current slot, and all outputs are served in a round-robin fashion. This can be used to simulate a router which has multiple routes to a destination and would like to use them simultaneously.

Hash classifiers are used when packets should be forwarded according to one or more packet fields (eg. flow id, source address).

Each Node in ns-2 has a predefined structure of classifiers, shown in Figures 4.3 and 4.4. The Node class provides a method `insert-entry` which allows the user to install additional classifiers at the node entry, i.e. any incoming packet will first be handled by the newly installed object. This functionality is used to “transform” nodes into MSC capable routers, as a newly created MSC classifier is installed at the selected nodes (for details see section 5.4 and Figure 5.2).

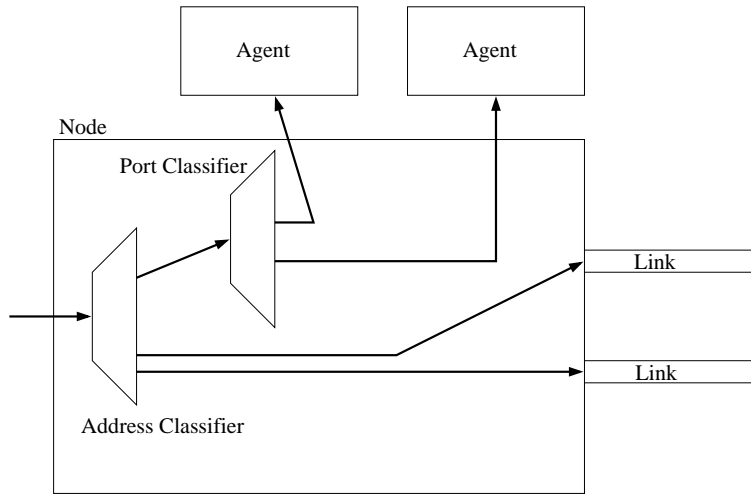

Figure 4.3: The internal structure of a standard ns-2 unicast Node. Any incoming packet is first handled by an address classifier which checks the destination field of the packet. If the packet is addressed to another Node, it is forwarded to the appropriate link. Otherwise a port classifier forwards the packet to the specified Agent.

4.5 Unicast and multicast in ns-2

For simulations that rely only on unicast, a simulator instance is invoked using the new `Simulator` command. Each unicast node created by this instance has a very simple predefined classifier structure, consisting mainly of an address classifier that forwards incoming packets either to an Agent installed on the node or an outgoing link (Figure 4.3).

In order to use multicast mechanisms, multicast has to be explicitly enabled when instantiating the simulator, using the new `Simulator -multicast` on command. Thus, nodes will be created with additional classifiers and replicators for multicast forwarding (Figure 4.4). Furthermore, a multicast routing protocol has to be specified and configured in the simulation script. In the 2.1b8 version of ns-2, two kinds of multicast protocols are supported [20]:

Dense Mode (DM) `DM.tcl` is an implementation of a dense-mode-like protocol. Depending on the value of DM class variable `CacheMissMode` it can run in one of two modes.

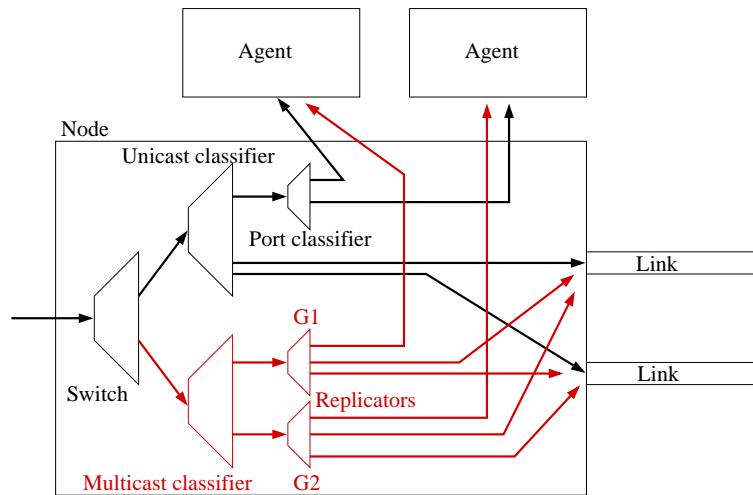

Figure 4.4: The internal structure of an ns-2 multicast Node. The first element in the classifier chain is a switch which separates unicast and multicast traffic. The multicast classifier determines the correct outgoing interfaces from the group address, while the replicators simply produce the required number of packet copies and forward them to the receivers (Agents and/or Links)

If `CacheMissMode` is set to `pimd` (default), PIM-DM¹ like forwarding rules will be used. Alternatively, `CacheMissMode` can be set to `dvmrp` (loosely based on DVMRP²). The main difference between these two modes is that DVMRP maintains parent-child relationships among nodes to reduce the number of links over which data packets are broadcast. The implementation works on point-to-point links as well as LANs and adapts to the network dynamics (links going up and down). Any node that receives data for a particular group for which it has no downstream receivers, sends a prune upstream. A prune message causes the upstream node to initiate prune state at that node. The prune state prevents that node from sending data for that group downstream to the node that sent the original prune message while the state is active. The time duration for which a prune state is active is configured through the DM class variable `PruneTimeout`.

Centralized Multicast (CtrMcast) Centralized multicast is a sparse mode implementation of multicast similar to PIM-SM³. A Rendezvous Point (RP) rooted shared tree is built for a multicast group. The actual sending of prune, join messages etc. to set up state at the nodes is not simulated (unlike in Dense Mode!). A centralized computation agent is used to compute the forwarding trees and set up multicast forwarding state, $\langle S, G \rangle$ at the relevant nodes as new receivers join a group. Data packets from the senders to a group are unicast to the RP. Note that data packets from the senders are unicast to the RP even if there are no receivers for the group. By concept, the RP sends the multicast packet to all group members, including the sender.

¹Protocol Independent Multicast - Dense Mode

²Distance Vector Multicast Routing Protocol

³Protocol Independent Multicast - Sparse Mode

4.6 Tracing in ns-2

4.6.1 Ns-2 tracefiles

The network simulator supports the collection simulation data in a tracefile. However, the user has to explicitly enable this feature by indicating the tracefile name and instructing the simulator to produce the relevant output. The necessary two lines of code can for example be found in the simulation script of section 4.3. Ns-2 records each individual packet as it arrives, departs, or is dropped at a link or queue. Unfortunately, the tracefile format is somewhat unelegant. As an example, the tracefile output of the Agent demo script from page 18 is listed below:

```
+ 0.1 0 1 udp 172 ----- 0 0.0 2.1 0 0
- 0.1 0 1 udp 172 ----- 0 0.0 2.1 0 0
r 0.111376 0 1 udp 172 ----- 0 0.0 2.1 0 0
+ 0.111376 1 2 udp 172 ----- 0 0.0 2.1 0 0
- 0.111376 1 2 udp 172 ----- 0 0.0 2.1 0 0
r 0.122752 1 2 udp 172 ----- 0 0.0 2.1 0 0
```

The events recorded in this context are packet enqueueing (+) and dequeueing (-) as well as packet arrival (r). For each event information such as current simulation time, packet source and destination address, packet type and size are written to the tracefile.

4.6.2 Nam

Nam (a part of the ns-2 distribution) is a Tcl/Tk based animation tool for viewing network simulation traces and real world packet tracedata. The design theory behind Nam was to create an animator that is able to read large animation data sets and be extensible enough so that it could be used in different network visualization situations. Under this constraint Nam was designed to read simple animation event commands from a large trace file. In order to handle large animation data sets a minimum of information is kept in memory. Event commands are kept in the file and reread from the file whenever necessary.

The first step to use Nam is to produce the trace file (not to be confused with the previously described ns-2 tracefile!). The trace file contains topology information, e.g. nodes, links, as well as packet traces and is structured similar to the ns-2 trace file. The MSC tracefile of the simulation script from section 5.3.3 is shown below.

```
V -t * -v 1.0a5 -a 0
A -t * -n 1 -p 0 -o 0xffffffff -c 31 -a 1
A -t * -h 1 -m 2147483647 -s 0
n -t * -a 0 -s 0 -S UP -v circle -c black -i black
n -t * -a 1 -s 1 -S UP -v circle -c black -i black
n -t * -a 2 -s 2 -S UP -v circle -c black -i black
l -t * -s 0 -d 1 -S UP -r 1000000 -D 0.01 -c black -o
l -t * -s 1 -d 2 -S UP -r 1000000 -D 0.01 -c black -o
+ -t 0.1 -s 0 -d 1 -p udp -e 172 -c 0 -i 0 -a 0 -x {0.0 2.1 0 ----- null}
- -t 0.1 -s 0 -d 1 -p udp -e 172 -c 0 -i 0 -a 0 -x {0.0 2.1 0 ----- null}
h -t 0.1 -s 0 -d 1 -p udp -e 172 -c 0 -i 0 -a 0 -x {0.0 2.1 -1 ----- null}
r -t 0.111376 -s 0 -d 1 -p udp -e 172 -c 0 -i 0 -a 0 -x {0.0 2.1 0 ----- null}
+ -t 0.111376 -s 1 -d 2 -p udp -e 172 -c 0 -i 0 -a 0 -x {0.0 2.1 0 ----- null}
- -t 0.111376 -s 1 -d 2 -p udp -e 172 -c 0 -i 0 -a 0 -x {0.0 2.1 0 ----- null}
h -t 0.111376 -s 1 -d 2 -p udp -e 172 -c 0 -i 0 -a 0 -x {0.0 2.1 -1 ----- null}
r -t 0.122752 -s 1 -d 2 -p udp -e 172 -c 0 -i 0 -a 0 -x {0.0 2.1 0 ----- null}
```

The events listed in the lower part of this tracefile (+, -, h,x) are similar to those of the ns tracefile shown in the previous section. In the first part of the Nam tracefile, the simulation topology and layout are recorded (n and l events). A detailed description of the Nam tracefile can be found in the ns manual [20].

Usually, the trace file is created by ns-2; for that to happen, namtrace has to be enabled. An example of how this is done can also be seen in the simulation script in section 4.3. After the trace file has been generated it is ready to be animated by Nam. Upon startup, Nam will read the tracefile, create topology, pop up a window, do layout if necessary, and then pause at (simulation) time 0. Through its user interface (Figure 4.5), Nam provides control over many aspects of the animation [20].

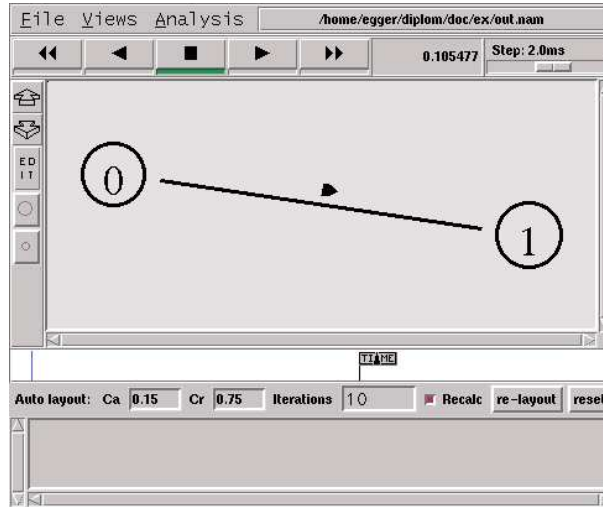

Figure 4.5: The Nam user interface with the above tracefile open.

5 MSC Implementation in ns-2

The following sections explain the necessary changes in existing ns-2 code and provide detailed descriptions of the newly created components that are used to simulate MSC capable end systems and routers. Example simulation scripts are provided to demonstrate the configuration and usage of these components. Guidelines for setting up faultless simulation scripts are also included.

5.1 Modifications and adaptations

The work on this thesis was performed with version 2.1 Beta 8 of the ns-2 software. This section contains a list of modifications and additions necessary to simulate Multicast for Small Conferences.

Modifications of existing files

The following list contains the names of all files that had to be modified as well as a brief description of the changes. For further information refer to the specific sections (where applicable).

packet.h.cc The `copy()` function was moved from `packet.h` to `packet.cc` to avoid dependency problems. Furthermore, the `copy()` function was modified for correct copying of the MSC routing header.

route.h.cc A new command `setRouteEntry` was implemented in the class `RouteLogic` and the method `compute_routes()` was modified. Both changes were necessary to make it possible to manually alter ns-2's default routing table. This feature is required when reproducing real-world networks in the simulator (see chapter 6).

udp.h.cc The `UdpAgent` class was enhanced to support the transmission of single packets of user-defined size. This feature is used when evaluating the performance of native multicast. Also, support for MSC trace files was included in the `UdpAgent` class.

ns-route.tcl A new procedure named `distance` was created. The function uses routing table information to calculate the distance (number of hops) between two nodes. It is used by MSC components for distance ordering of addresses in an MSC address list.

ns-node.tcl This class features a new procedure named `insert-mscr` which is used for the installation of the `MSCRouter` component.

ns-default.tcl A new line was inserted to set the `packetSize_default` value for the MSC packet type.

New files

The following C++ files were added to ns-2 in order to simulate Multicast for Small Conferences:

msc_hdr.h This file defines the MSC packet header used in ns-2.

msc.h/cc Define the `MSCAgent` and the `NaiveAgent` classes.

mscrouter.cc A new ns-2 classifier which is used for MSC router simulation.

emscrouter.cc Another ns-2 classifier, used for the simulation of enhanced MSC.

Obviously all new files had to be included into the `Makefile`.

No new Tcl files have been created.

5.2 The MSC protocol in ns-2

Since ns-2.1b8 does not directly support the simulation of IP Version 6 and specifically provides no support for the simulation of a variable size routing header, a new packet header structure was introduced (file `msc_hdr.h`). This creates a new packet type `MSC` which is linked to the `MSCAgent` class, i.e. each packet allocated by such an Agent will be of this type. Also, every `MSC` packet will have an initial size of 204 bytes, as this value is stored in the file `ns-default.tcl` as the default overall packet length. This value is based on the assumption of sending audio data over RTP, UDP and IP; details are discussed in section 7.2. As has already been briefly explained in section 4.2, the simulator distinguishes between its internal packet header and the actual (simulated) packet consisting of packet headers and payload. Also, the structure of the internal packet (protocol) headers do not necessarily reflect the fields of the actual protocol.

The newly defined `MSC` packet header defines the following fields:

vector<ns_addr_t>* otherRecvs The IPv6 routing header is simulated with a `vector` from the Standard Template Library. This variable stores a pointer to this `vector`. The actual address list carried in a routing header cannot be stored in the `MSC` packet header since ns-2 only supports fixed size headers (i.e. the header size is set at compilation time).

double sendTime When an `MSCAgent` (`MSC` end system) sends a packet it will store the simulation time in this variable. Calculation of the difference between the simulation time on packet arrival and the value stored in this variable allows to determine the enroute time of a packet. This feature is used for the performance analysis. The timestamp (`ts_`) field in the common header cannot be used for this purpose since it is used specifically for measurement of queueing delays and thus is altered every time the packet enters or leaves a queue.

ns_addr_t origin Whenever an `MSCAgent` allocates a new `MSC` packet it will store its own address in this field. Receiving agents use this information to determine the original sender of a packet. The `src_` field of the ns-2 IP header cannot be used for this purpose since every Agent that receives and re-sends a packet has to modify it (otherwise multicast protocols that use the source address for packet forwarding might get confused). This field is also used to collect information used for the performance evaluation.

int lastttl In order to determine the bandwidth used in MSC simulations it is necessary to know the number of hops a packet has travelled since last encountering an MSC component (router or end system). Since it is unwise to alter the IP TTL field, each MSC host or router stores the current IP TTL in this field. The next receiver then determines the number of links the packet travelled by calculating the difference of the two fields.

It is important to realize that these fields do not correspond to the MSC specification; instead, they are used internally by the simulator. In particular, the size of this packet header (pointer+double+ns_addr_t) is not used to determine the simulated packet size (but the number of elements stored in the `otherRecvs` variable is). Details about the difference between the simulated packet and ns-2's internal representation have been discussed in section 4.2, while the simulated packet size is explained in section 7.2.

Note that the multicast group address, which would normally be carried at the end of the IPv6 routing header, is not stored in the MSC header, since it is not required for the simulations. However, the 16 bytes consumed by the group address as well as the 16 bytes used by the routing header (overhead) in which it is carried are taken into account when calculating the packet size, i.e. they are included in the default packet size.

5.3 Implementing end system MSC in ns-2

5.3.1 The MSCAgent class

The `MSCAgent` class is used to simulate the behavior of MSC capable end systems. The functionality of these is described in Chapter 3.2. Outgoing packets must contain the list of receivers in the routing header, while incoming packets have to be handed over to higher level protocols as well as forwarded to the next receivers (if any). Since packet processing in upper layers is not relevant for this performance simulation, the `MSCAgent` is basically a network (IP) layer Agent. As proposed in Chapter 10.6.1 of the ns manual [20], Agent is used as the base class.

MSCAgent commands

The following commands are supported for use from the simulation script:

addDestination This command is given with a list of Agents (addresses). The `MSCAgent` adds these addresses to its internal list of destinations.

send On invocation of this command the `MSCAgent` creates a new packet which carries all receivers specified in the internal address list (the first address is copied to the destination field, the others are carried in the routing header).

An example of how `MSCAgents` and their commands are used can be found in section 5.3.3.

5.3.2 MSCAgent internals

Sending packets

When the `send` command is issued, the `sendmsg` method in the class `MSCAgent` is invoked. This function allocates a new packet from the Simulator, which already fills in a few fields

in the common header and in the IP header. The most important of these are `pType` (packet type), `size` (packet size in bytes), `src` (source address) and `dst` (destination address). For the MSCAgents, packet type will be `MSC`, packet size is 204 bytes (the default value set in `ns-default.tcl`), and the source address is the node on which the Agent is installed. The destination field will be empty unless a `connect` command has been issued or the MSCAgent has joined a multicast group. Once the MSCAgent can access the packet, it will replace any preset destination address with the first address in its internal address list (which contains the addresses of all receivers and is ordered by distance). The rest of the destination addresses are stored in the vector of the MSC header (simulating the IPv6 routing header). After saving the sending time in the common header the packet is forwarded to the next network element by invoking the `send` method of the Agent superclass `Connector`.

Receiving packets

An MSCAgent receives a packet when its `recv` method is invoked by the network component that is forwarding the packet. First, the MSCAgent checks the packet type; normally, any packet routed to the MSCAgent should have packet type `MSC`. Therefore packets of all other types are simply discarded. For `MSC` packets, the delay is calculated from the sending time stored in the MSC header and the actual simulation time. The MSCAgent then checks the size of the simulated routing header. If the vector is not empty, the first entry is moved to the packet destination field, the source address is updated, and the packet is re-sent. No other fields of the packet are changed - packet ID and send time remain unchanged, which is important for tracing. Should the vector be empty (i.e. no more receivers) the packet is discarded.

5.3.3 Example

This is a sample Tcl script which shows the usage of MSCAgent. Note that issuing a `connect` command to the Agents is not necessary (and actually useless) since the destination address is inserted into the IP header based on the group information provided through the `addDestination` command.

```
# MSC end system demo
#
#
#           (2)           (5)
#           |             |
# (0)---(1)---(3)---(4)---(6)
#
#
# sender:    0
# receivers: 2 5 6
#
#
set ns [new Simulator]

# open nam trace file
set nf [open out.nam w]
$ns namtrace-all $nf
```

5 MSC Implementation in ns-2

```
# use a "normal" ns trace file as well:
set tracefile [open trace.ns w]
$ns trace-all $tracefile

proc finish {} {
    global ns nf tracefile
    $ns flush-trace
    close $nf
    close $tracefile

    exec nam out.nam &
    exit
}

# create nodes
set n0 [$ns node]
set n1 [$ns node]
set n2 [$ns node]
set n3 [$ns node]
set n4 [$ns node]
set n5 [$ns node]
set n6 [$ns node]

# create links
$ns duplex-link $n0 $n1 1Mb 10ms DropTail
$ns duplex-link $n1 $n2 1Mb 10ms DropTail
$ns duplex-link $n1 $n3 1Mb 10ms DropTail
$ns duplex-link $n3 $n4 1Mb 10ms DropTail
$ns duplex-link $n4 $n5 1Mb 10ms DropTail
$ns duplex-link $n4 $n6 1Mb 10ms DropTail

# setup MSC end systems
set msc0 [new Agent/MSCAgent]
$ns attach-agent $n0 $msc0
set msc2 [new Agent/MSCAgent]
$ns attach-agent $n2 $msc2
set msc5 [new Agent/MSCAgent]
$ns attach-agent $n5 $msc5
set msc6 [new Agent/MSCAgent]
$ns attach-agent $n6 $msc6

# define the MSC multicast group
$msc0 addDestination $msc2 $msc5 $msc6

# send a single packet
$ns at 0.1 "$msc0 send"

# end simulation
$ns at 1.0 "finish"

# run the simulation
$ns run
```

Running the simulation in Nam shows that the packet travels from one member of the MSC group to the next, i.e. from node 0 to Node 2, then to node 5, finally arriving at node 6 with a considerable delay (Figure 5.1). However, the routers on nodes 1, 3 and 4 did not have to provide any multicast functionality. Since each link has a delay of 10 milliseconds (set in the simulation script), the delay is 20ms for node 2, 60ms for node 5 and 80ms for node 6 (ignoring queuing delays).

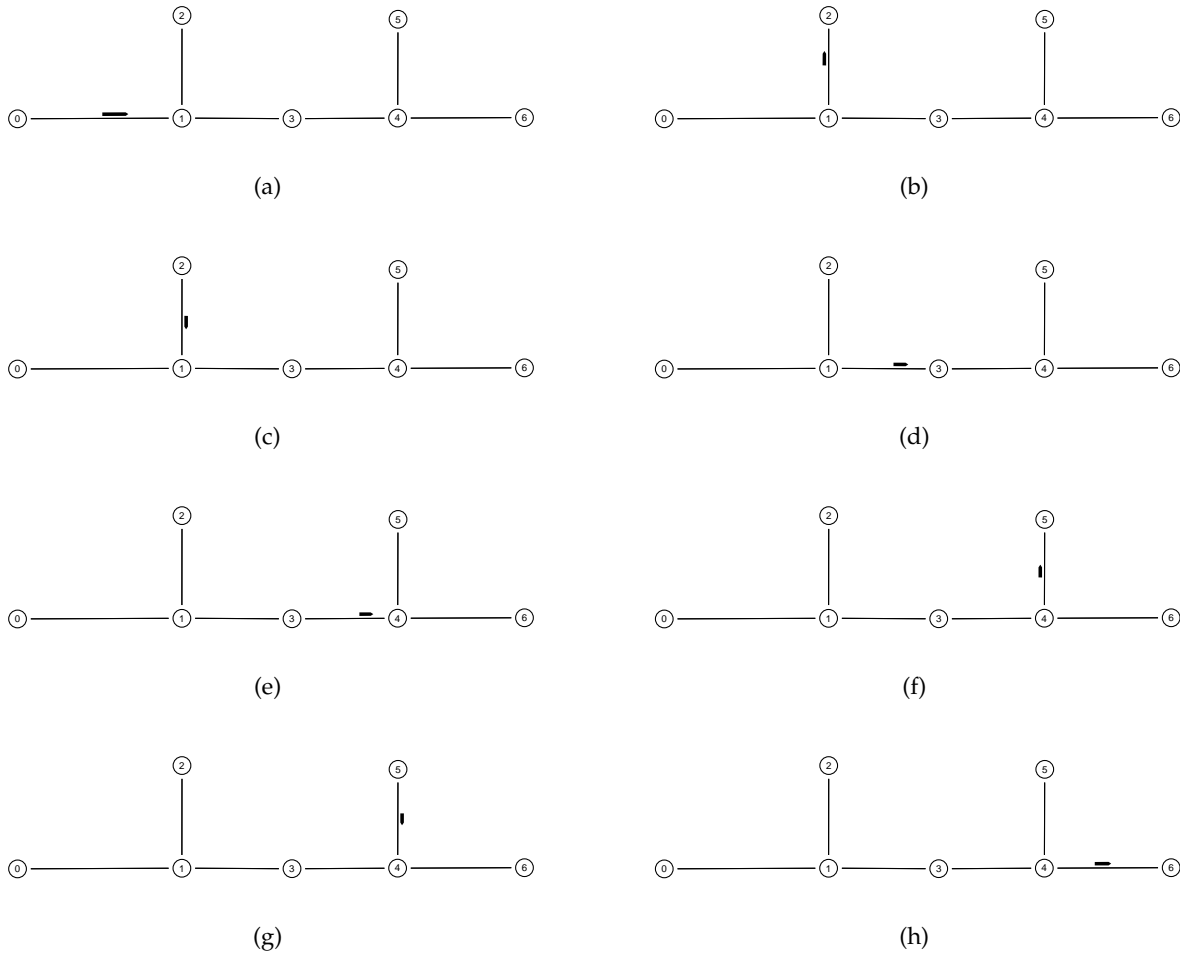

Figure 5.1: The Nam output created by the above simulation. After Node 0 sends the packet to Node 2 (a)-(b) it is forwarded to Node 5 (c)-(f) and finally arrives at Node 6 (g)-(h).

5.3.4 The NaiveAgent class

This class extends the MSCAgent, but does not actually implement Multicast for Small Conferences. Instead, the NaiveAgent class is used for the simulation of naive unicast, where a sender produces a packet copy for each recipient. The NaiveAgent supports the same commands as an MSCAgent and also maintains an address list. The two Agents only differ in the packet sending behavior.

5.4 Implementing MSC capable routers

5.4.1 The MSCRouter class

As mentioned in section 4.4, MSC router functionality is implemented in ns-2 with a special classifier, implemented in the `MSCRouter` class. The structure of this classifier is quite similar to the ns-2 `Replicator` class, which also inherits from `Classifier`. But unlike the `Replicator` the `MSCRouter` has only one exit.

After such a component is installed on a node using the `insert-mscr` command, every packet arriving at an MSC enhanced node will first be handled by the `MSCRouter` (unless other modules are installed from the simulation script) and is then forwarded to the classifier structure defined by the simulator (Figure 5.2). This concept has the major advantage of making the MSC functionality completely independent from the rest of the Node (e.g. attached Agents, Links and routing modules).

`MSCRouters` provide no special functionality to the ns-2 user and need no configuration.

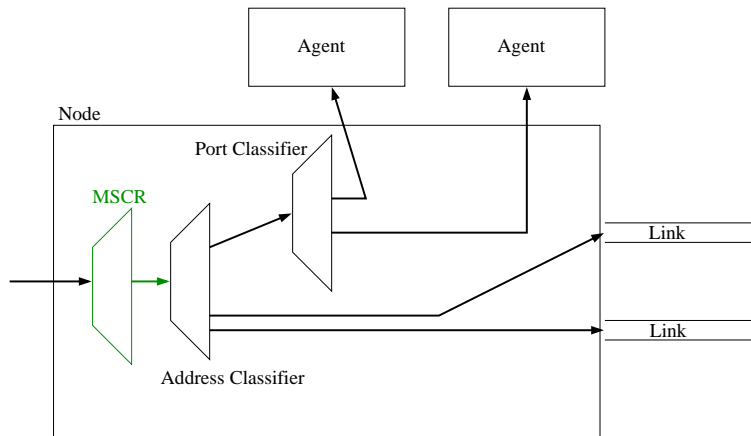

Figure 5.2: The internal structure of an MSC Router node. Each incoming packet is first handled by the MSC classifier (class `mscr`) which performs the necessary routing table lookups and packet duplications. Afterwards the packet(s) are forwarded to the existing classifier structure. MSC can also be used with a multicast-enabled Node (Figure 4.4).

5.4.2 MSCRouter internals

Variables and commands

The `MSCRouter` has a variable `hostNodeID` which contains the identification of the node on which the `MSCRouter` is installed. The value is set by issuing the `set-hostNode` command with the ID as argument, which is done by the `install-mscr` procedure (defined in `ns-node.tcl`). The `MSCRouters` needs the `hostNodeID` to perform routing table lookups, since the simulator does not maintain a private routing table for each node when static routing is used.

Packet handling

The first test the MSCRouter performs on an incoming packet is for the packet type. If it is not MSC (i.e. the packet is not part of an MSC session, but rather another unicast or multicast transmission), the packet is forwarded without any modification. On arrival of an MSC packet the MSCRouter checks the size of the routing header. If this value is not zero, the MSCRouter performs a routing table lookup on all destination addresses listed in the packet (destination field and routing header). This information is then used to create the appropriate number of outgoing packets, each with the relevant addresses, according to the MSC specification (see 3.2.2). The address lists are sorted by distance from the node on which the MSCRouter is installed. All other fields in the packet headers except for the source address remain unchanged.

5.4.3 Example

The effect of an MSC router can be demonstrated using the script from section 5.3.3 as a basis. Inserting the following lines directly after the creation of the nodes “transforms” nodes 1 and 4 into MSC-capable routers:

```
# MSC router
$n1 insert-mscr "" [new Classifier/MSCRouter] 0
$n4 insert-mscr "" [new Classifier/MSCRouter] 0
```

The analysis with Nam (Figure 5.3) shows that the MSC router on Node 1 duplicates the incoming packet (b) and sends one copy to node 2 and one copy to Node 3. Similarly, Node 4 sends packets to Nodes 5 and 6 (c). The delay from the sender to host 2 is still the same as in the previous example (about 20ms), while the delay to hosts 5 and 6 is only about 40ms (compared to 60-80ms). This indicates the potential performance gain achievable with MSC routers.

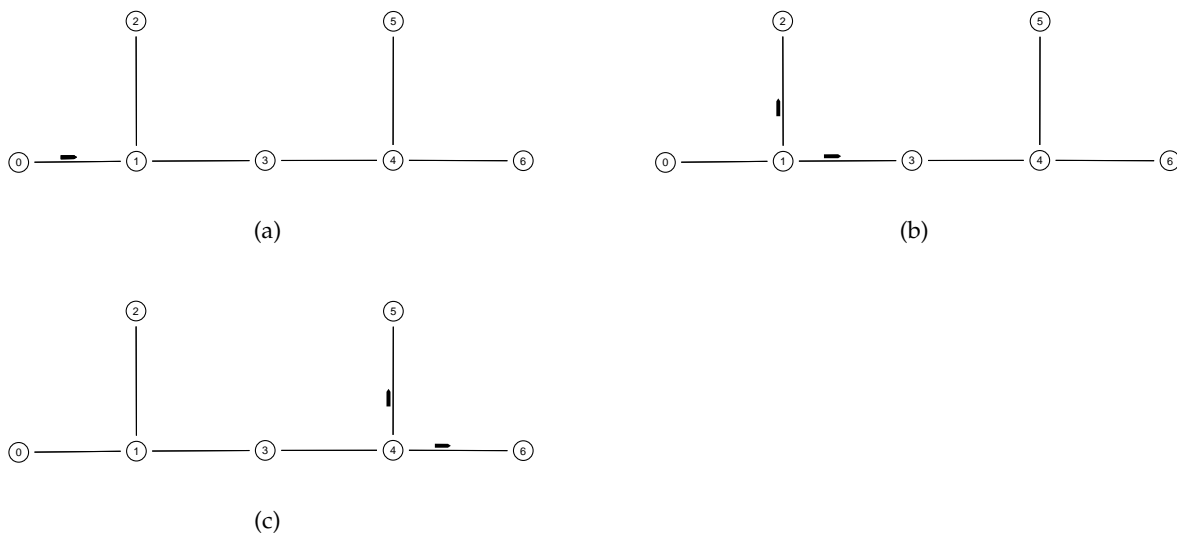

Figure 5.3: Nam output of the simulation using MSCRs.

5.4.4 The EMSCRouter class

This class implements the MSC enhancement presented in section 3.2.2, i.e. it determines the egress router for all addresses in the routing header and duplicates packets accordingly.

The basic structure of the `EMSCRouter` class is exactly the same as that of the `MSCRouter` class described in the previous section. The usage in the simulator differs only in that the enhanced MSC router requires the definition of a local network domain (see example in section 5.4.6). Thus it offers a command for configuration from the simulation script.

5.4.5 EMSCRouter internals

Additional variables and commands

In addition to the variable `hostNodeID` defined by the `MSCRouter` class, the `EMSCRouter` uses the integer array `localDomainIDs` to store the IDs of nodes of the "local" network. This domain has to be defined by the user through invocation of the `setLocalDomain` command (with a list of node IDs as arguments) from the simulation script. The method `isInLocalDomain` can be used to determine whether a given address is in the local scope or not.

Packet handling

Initially, the `EMSCRouter` class performs the same operations on incoming packets as does the `MSCRouter` class; this results in a number of packets (one for each outgoing interface). The address list of each of these packets is then analysed again, and the egress router is determined for each destination. This is done through a series of `lookup` commands on the routing table, by which the last hop inside the local network is detected. If necessary, additional packet copies (one per egress router) are created.

5.4.6 Example

This example for the use of an enhanced MSC router uses a different topology than the previous examples. However, the rest of the script remains unchanged, except for the configuration of the enhanced MSC router.

```
# Enhanced MSC demo
#
#
#      (3)---(4)--\      (6)
#      |           (5)--<
# (0)---(1)---(2)--/      (7)
#      |
#      (8)
#
# sender:    0
# receivers: 6 7 8
# enhanced MSC router on node 1
# nodes 1-5 form a network domain
#

set ns [new Simulator]
```

5 MSC Implementation in ns-2

```
# open nam trace file
set nf [open out.nam w]
$ns namtrace-all $nf

# use a "normal" ns trace file as well:
set tracefile [open trace.ns w]
$ns trace-all $tracefile

proc finish {} {
    global ns nf tracefile
    global ns nf
    $ns flush-trace
    close $nf
    close $tracefile

    exec nam out.nam &
    exit
}

# create nodes
set n0 [$ns node]
set n1 [$ns node]
set n2 [$ns node]
set n3 [$ns node]
set n4 [$ns node]
set n5 [$ns node]
set n6 [$ns node]
set n7 [$ns node]
set n8 [$ns node]

# EMSC router
set emscrouter [new Classifier/EMSCRouter]
$emscrouter setLocalDomain $n1 $n2 $n3 $n4 $n5
$n1 insert-mscr "" $emscrouter 0

# create links
$ns duplex-link $n0 $n1 1Mb 10ms DropTail
$ns duplex-link $n1 $n2 1Mb 10ms DropTail
$ns duplex-link $n1 $n3 1Mb 10ms DropTail
$ns duplex-link $n2 $n5 1Mb 10ms DropTail
$ns duplex-link $n2 $n8 1Mb 10ms DropTail
$ns duplex-link $n3 $n4 1Mb 10ms DropTail
$ns duplex-link $n4 $n5 1Mb 10ms DropTail
$ns duplex-link $n5 $n6 1Mb 10ms DropTail
$ns duplex-link $n5 $n7 1Mb 10ms DropTail

# setup MSC end systems
set msc0 [new Agent/MSCAgent]
$ns attach-agent $n0 $msc0
set msc6 [new Agent/MSCAgent]
$ns attach-agent $n6 $msc6
set msc7 [new Agent/MSCAgent]
```

5 MSC Implementation in ns-2

```
$ns attach-agent $n7 $msc7
set msc8 [new Agent/MSCAgent]
$ns attach-agent $n8 $msc8

# define the MSC multicast group
$msc0 addDestination $msc6 $msc7 $msc8

# send a single packet
$ns at 0.1 "$msc0 send"

# end simulation
$ns at 1.0 "finish"

# run the simulation
$ns run
```

In order to illustrate the concept of enhanced MSC we assume that Nodes 1 to 5 form a network domain (e.g. a backbone network). The rest of the nodes act as end systems connected to that domain. Node 0 is the sender, while Nodes 6, 7 and 8 are receivers.

The analysis with Nam (Figure 5.4) shows what happens. The enhanced MSC router on Node 1 determines the outgoing egress routers: Node 2 for the host on Node 8 and Node 5 for the other two destinations. Thus, two packet copies are created: A packet with an empty routing header (except for the multicast address) is sent to Node 6, while the other packet is addressed to Node 7 and carries the address of Node 8 as well. The effect is that two packets with identical payload are sent across the link between Nodes 1 and 2 (b). This is offset by the fact that no packet will travel from Node 6 to Node 2, since no forwarding is necessary (c). However, packet forwarding is necessary between Nodes 5 and 6, because no MSC router has been installed on Node 5 (d)-(f).

5.5 MSC component tracing features

Since Nam does not provide the functionality to automatically analyse data and the ns tracefile is a bit inconvenient, MSC components implement their own tracing functionality. The concept is very simple: each MSC component writes events to an MSC tracefile (which is an ordinary textfile) named `msctrace.ns`. Each host and router records certain events:

<i>component</i>	<i>event</i>	<i>tracefile line</i>
MSCAgent	packet arrival	MSCA <node> rcv <from> <delay>
	sending (new packet)	MSCA <node> send <to> <size>
	forwarding (after rcv)	MSCA <node> fwr <to> <size>
MSCRouter	packet forwarding	MSCR <node> fwr <to> <size>

The <node>, <from> and <to> values stand for the IDs of the host node, source and destination addresses respectively. <size>, also an integer value, is the size (in bytes) of the sent or forwarded packet.

While the events listed above can be used to record the course of MSC handling and for delay analysis, additional functionality is needed to analyse bandwidth consumption. Therefore,

5 MSC Implementation in ns-2

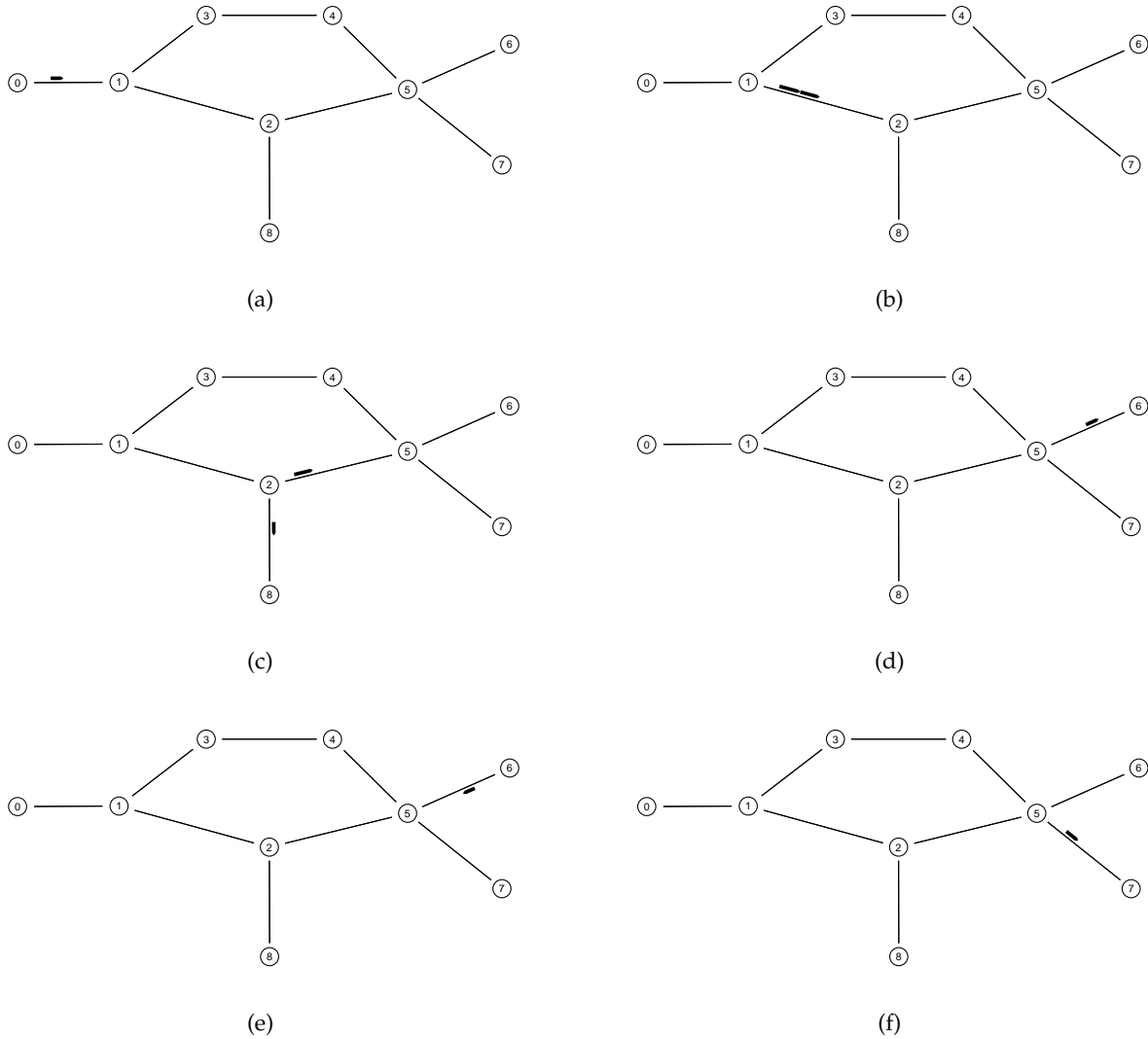

Figure 5.4: The Nam output of the EMSCR example script.

all MSC components also support the special `bwcs` event:

```
MSCX bwcs <consumption>
```

The `consumption` value is calculated by each MSC component receiving an MSC packet by multiplying the size (in bytes) of the incoming packet with the number of links used since the last MSC component handled the packet. The links are counted by calculating the difference between the packet's (IP) TTL field and the value stored in the `lastttl` value stored in the MSC header. Each MSC host or router updates this field by copying the actual TTL value before forwarding a packet.

In order to simplify the analysis of the reference scenarios using native multicast, the `UdAgent` class was enhanced to support the same tracing features as the `MSCAgent` class (including the `bwcs` event). The same is obviously true for the `NaiveAgent` class, as it extends

the MSCAgent class. Shown below is the MSC tracefile written by the MSC components when executing the simulation script from section 5.4.6.

```
MSCA 0 send 8 236
MSCX 1 bwcs 236
MSCR 1 fwrdd 8 204
MSCR 1 fwrdd 6 220
MSCA 8 recvd 0 35.152000
MSCX 8 bwcs 408
MSCA 6 recvd 0 48.800000
MSCX 6 bwcs 660
MSCA 6 fwrdd 7 204
MSCA 7 recvd 0 72.064000
MSCX 7 bwcs 408
```

5.6 Running MSC simulations

Ns-2 simulations involving MSC components can be set up and run like any other simulation by defining the necessary installations and events in a Tcl file. To avoid problems during the initialization, the following structure should be used (with or without MSC components involved):

Simulator instantiation

Node definitions

Classifiers instantiation and installation of MSCRouters and any other user-defined classifiers

Link definitions

Multicast protocols initialization and configuration of multicast protocols

Agents instantiation, configuration and installation of MSC(G)Agents and other Agents

Routing changes `setRouteEntry`, `addRoute` and `deleteRoute` commands

Events scheduling of simulation events

Maintaining this sequence is important for a number of reasons:

- The classifiers are installed inside the nodes, therefore these have to be defined first.
- The links are connected to classifiers, and therefore all classifiers have to be installed before the links are defined.
- Multicast protocol configuration requires topology information; therefore nodes and links have to be defined at the time multicast protocols are introduced.
- Routing changes can only take effect after all nodes and links are set up. The influence of routing changes on the multicast protocol configuration does not have any implications, as the multicast protocols re-calculate the relevant parameters automatically when the routing table is modified.

5 *MSC Implementation in ns-2*

MSCAgents and MSCRouters impose no special restrictions on the user and can be combined with other ns-2 components.

6 Simulation Topology

This chapter focuses on the simulation model used for the performance evaluation of Multicast for Small Conferences. It first describes the key idea before presenting the real-world networks and end systems used to build the simulation topology. The last section discusses the integration of real-world data in the network simulation software.

6.1 Introduction

The major goal of this thesis was to use the new ns-2 components for a basic performance study of the Multicast for Small Conferences protocol. Since choosing an appropriate topology is critical for useful results, it makes sense to base the simulation on real-world information. Since MSC has particularly been developed for use in backbones, basing the simulation scenarios on information from actual Internet backbone networks was the obvious thing to do. While this provided the structure for the “backbone” of the simulation topology it was still necessary to add a number of nodes to simulate the end systems. For the simulations in this project, this role is played by web servers of universities connecting to the Internet via the selected backbone networks. Using the web servers (i.e. the host that responds to queries for `www.universityname.edu`) makes sense since well-known names can be used and no special information (IP addresses or hostnames) is required. Furthermore, the delay between the web server and any other host in the university networks should be negligible.

6.2 Backbone networks

In order to reproduce the characteristics of the real-world topologies in the simulation software it is vital to choose networks about which a lot of information is available. This comprises the structure (topology) of the network as well as data about bandwidth, delays and routing. Since information from universities and research institutions is more easily available than data from commercial networks, the simulation topology for this thesis is based on data from a number of (academic) research networks.

The following backbone networks (or parts of them) were used to set up the simulation topology:

The Pan-European Gigabit Research Network (Géant)

Géant is a four-year project, set up by a Consortium of 27 European national research and education networks (NRENs), with Dante [9] as its co-ordinating partner. Co-funded by the European Commission as part of its Framework V Programme, its goal was the improvement of the previous generation of pan-European research network, TEN-155, by creating

a backbone at Gigabit speeds. It connects over 3'000 research and education institutions in over 30 countries and connects to several research networks in other world regions [13] (Figure 6.1).

The Italian Academic and Research Network (Garr)

Garr (Gruppo per l'Armonizzazione delle Reti della Ricerca - Research Networks Harmonisation Group) is composed by all subjects representing the Italian Academic and Scientific Research Community. A major part of its mission is to provide interconnection with other European and worldwide research networks and with the Internet [12] (Figure 6.2).

Abilene

Abilene is a high-performance network developed by the University Corporation for Advanced Internet Development (UCAID). It connects regional network aggregation points in the United States, called GigaPoPs, to support the work of Internet2 [17] universities as they develop advanced Internet applications. Abilene connects to other high-performance research networks [1] (Figure 6.3).

Swiss Academic & Research Network (Switch)

The Switch foundation was established in 1987 by the Swiss Confederation and the eight university cantons to promote modern methods of data transmission and to set up and run an academic and research network in Switzerland. All Swiss universities and some R&D institutions are connected to the Internet via the SWITCHlan backbone [28].

German Research Network (DFN/G-WiN)

DFN [11] is the computer-based communication infrastructure for science, research and education in Germany. G-WiN is the core of the DFN infrastructure and employs state-of-the-art optical fibre technology. DFN also offers high performance connections to other networks, in particular Abilene and Géant [11].

6.3 End systems

The web servers to serve as end systems were selected from the large number of universities and research institutions connecting to the Internet via the backbone networks listed in the previous section. The goals were

- a) to have at least one end system per backbone router
- b) to have enough end systems to allow simulations with groups of up to 20 hosts
- c) to have a distribution of end systems which allows simulations with different degrees of clustering.

Furthermore, the web servers of the selected institutions had to allow (i.e. respond to) `ping` and `traceroute` commands; otherwise delay measurements (described in section 6.4) would

have been impossible.

The end systems used to set up the simulation topology are listed in Table 6.1.

6.4 Real-world data and ns-2

Network topology and bandwidth information for all the networks listed in section 6.2 are available from their respective websites. However, it was necessary to manually obtain information about the routing inside these networks as well as to measure the delays on the backbone links and from the backbone routers to the connected end systems.

In order to get a somewhat realistic picture of the delays, a large number of `ping` and `traceroute` measurements were performed from looking glasses in the backbone networks and the end systems. To avoid distortions caused by the changing loads during a day, all data was collected on a single weekday (Tuesday, February 19, 2002) between 1500 and 1800 MET¹. Thus, the networks in Europe as well as those in North America should show representative delays.

Due to the large number of `traceroute` commands performed it was possible to get at least three measurements on each backbone link. In the `traceroute` outputs, the relevant hosts were identified and the round-trip time between them was calculated. For most links, the different measurements yielded very similar results (i.e. differences of less than 2 ms). Where this was not the case, particularly in the GARR network additional measurements were performed to permit the calculation of a useful delay value. Averaging all round-trip times and assuming $\text{delay} = \text{rtt}/2$, the delay was established for each link in the (simplified) topology. The `traceroute` data also provided routing information which is used to adjust ns-2's default routing in the simulation topology.

The simulation topology in ns-2 was set up according to the topology maps available from the websites of the selected research networks. To avoid needless overhead, the end system nodes are directly connected to the next backbone router node. In reality, a number of hosts usually lay inbetween the two (gateways etc), but they can be left out in this context as they are not relevant for the simulation. The delay on the direct link just incorporates the overall delay between the end system and the backbone access point. The resulting ns-2 topology, consisting of 78 nodes and 89 links, is shown in figure 6.4.

The routing differences between the real-world networks (observed with `traceroute`) and ns-2's default routing were offset by adding a number of `setRouteEntry` commands (newly defined in `route.cc`) to the simulation script. Using `setRouteEntry` it is possible to alter the simulator's global routing table at runtime from the simulation script.

¹MET: Mid European Time, i.e. UTC+1

6 Simulation Topology

<i>City/Region</i>	<i>Abbr</i>	<i>webservice URL</i>	<i>Institution</i>
Bern	BRN	www.unibe.ch	University of Bern
Geneva	GVA	www.unige.ch	University of Geneva
Munich	MUC	www.tu-muenchen.de	Technische Universität München
Hamburg	HAM	www.tu-hamburg.de	Technische Universität Hamburg
St. Etienne	STE	www.univ-st-etienne.fr	Université Jean Monnet
Oslo	OSL	www.uio.no	University of Oslo
Stockholm	STO	www.kth.se	Royal Institute of Technology
Iceland	REK	www.hi.is	University of Iceland
Torino	TO	www.unito.it	University of Torino
Genova	GE	www.unige.it	University of Genova
Milano	MI	www.unimi.it	University of Milano
Padua	PD	www.unipd.it	University of Padova
Trieste	TS	www.units.it	University of Trieste
Bologna	BO	www.unibo.it	University of Bologna
Firenze	FI	www.unifi.it	University of Firenze
Pisa	PI	www.unipi.it	University of Pisa
Perugia	PG	www.unipg.it	University of Perugia
Roma	RM	www.uniroma1.it	University of Roma
Frascati	FR	www.mporzio.astro.it	Rome Astronomical Observatory
Aquila	AQ	www.univaq.it	University of L'Aquila
Cagliari	CA	www.unica.it	University of Cagliari
Napoli	NA	www.unina.it	University of Napoli
Bari	BA	www.uniba.it	University of Bari
Cosenza	CS	www.unical.it	University of Calabria
Catania	CT	www.unict.it	University of Catania
Palermo	PA	www.unipa.it	University of Palermo
Berkeley	JBK	www.berkeley.edu	UCAL Berkeley
Stanford	SFO	www.stanford.edu	Stanford University
Irvine, CA	IRV	www.uci.edu	UCAL Irvine
San Diego	SAN	www.scsd.edu	Supercomputing Center
Los Angeles	LAX	www.ucla.edu	UCAL Los Angeles
Riverside	RIV	www.ucr.edu	UCAL Riverside
Santa Barbara	SBA	www.ucsb.edu	UCAL Santa Barbara
Anchorage	ANC	www.uaa.alaska.edu	University of Alaska, Anchorage
Seattle	SEA	www.washington.edu	University of Washington
Dallas	DFW	www.utdallas.edu	University of Texas, Dallas
Maryland	BWI	www.umd.edu	University of Maryland
Princeton	PCT	www.princeton.edu	Princeton University
Pittsburgh	PIT	www.cmu.edu	Carnegie Mellon University
Cincinnati	CVG	www.cu.edu	University of Cincinnati
Wisconsin	WIS	www.wisc.edu	University of Wisconsin-Madison
Iowa	IOW	www.iastate.edu	Iowa State University
Eugene, OR	EUG	www.uoregon.edu	University of Oregon
Tucson	TUS	www.arizona.edu	University of Arizona
College St. TX	CLL	www.tamu.edu	Texas A&M University
Florida	MIA	www.ufl.edu	University of Florida
New York	NYC	www.columbia.edu	Columbia University NYC
Buffalo	BUF	www.buffalo.edu	University of Buffalo, NY
Washington	DCA	www.gwu.edu	George Washington University
New York	ALB	www.albany.edu	NY State University
New York	BGM	www.binghamton.edu	NY State University
Boston	BOS	www.mit.edu	Massachusetts Institute of Technology

Table 6.1: The evaluated end systems; the topology is shown in Figure 6.4.

6 Simulation Topology

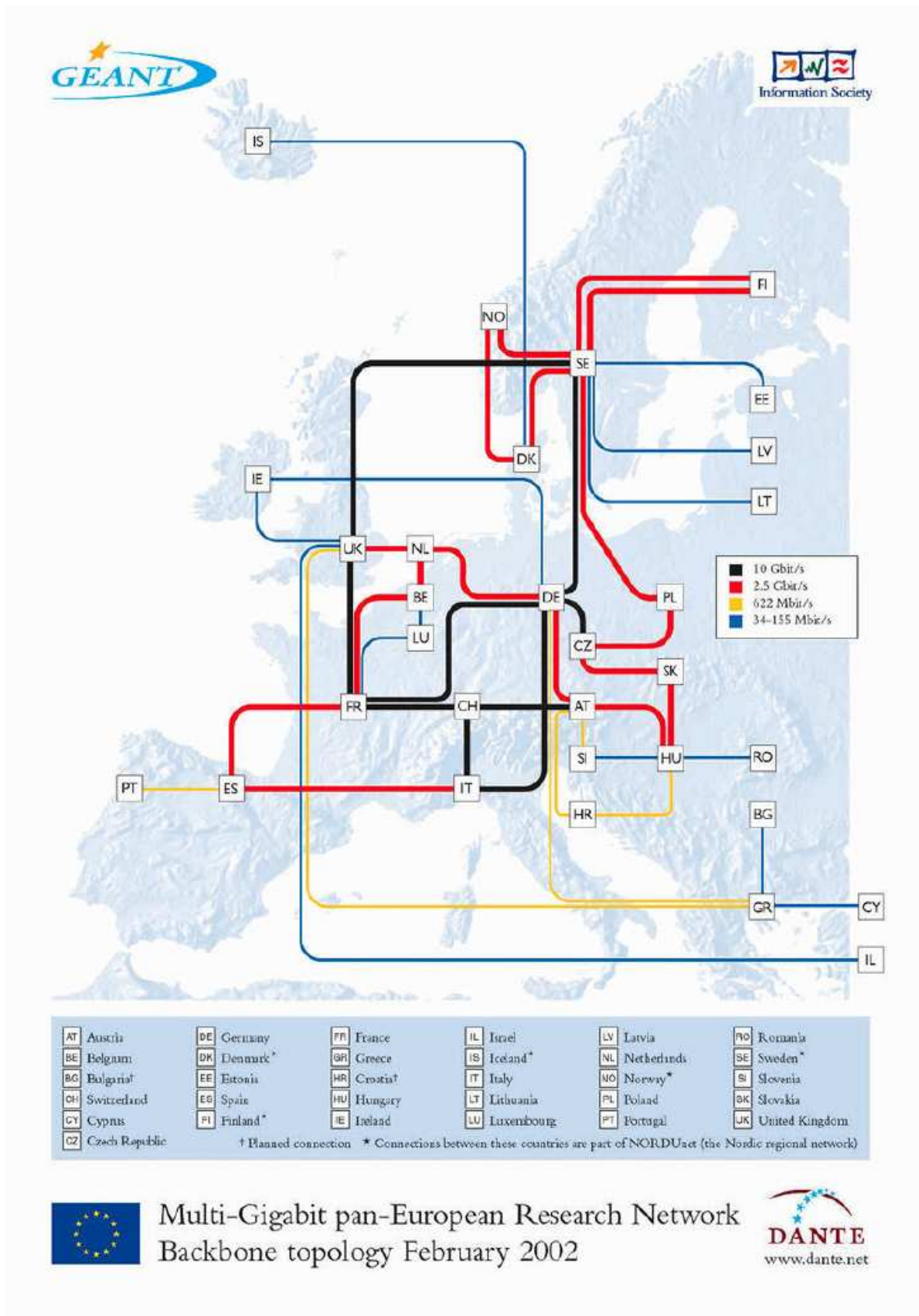

Figure 6.1: Géant topology map



Figure 6.2: Garr topology map

Abilene Network Backbone - February 2002

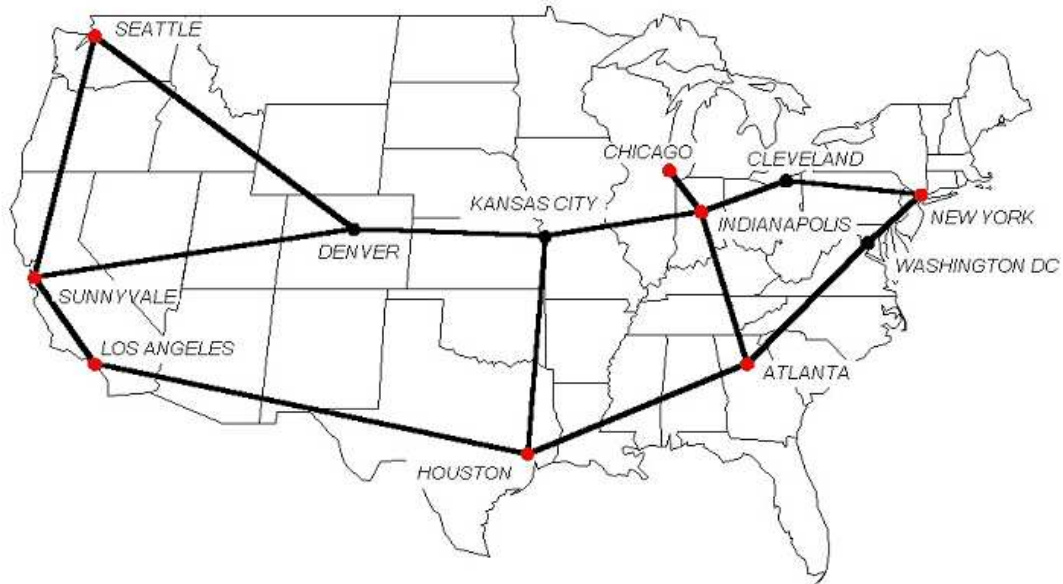

Figure 6.3: Abilene topology map

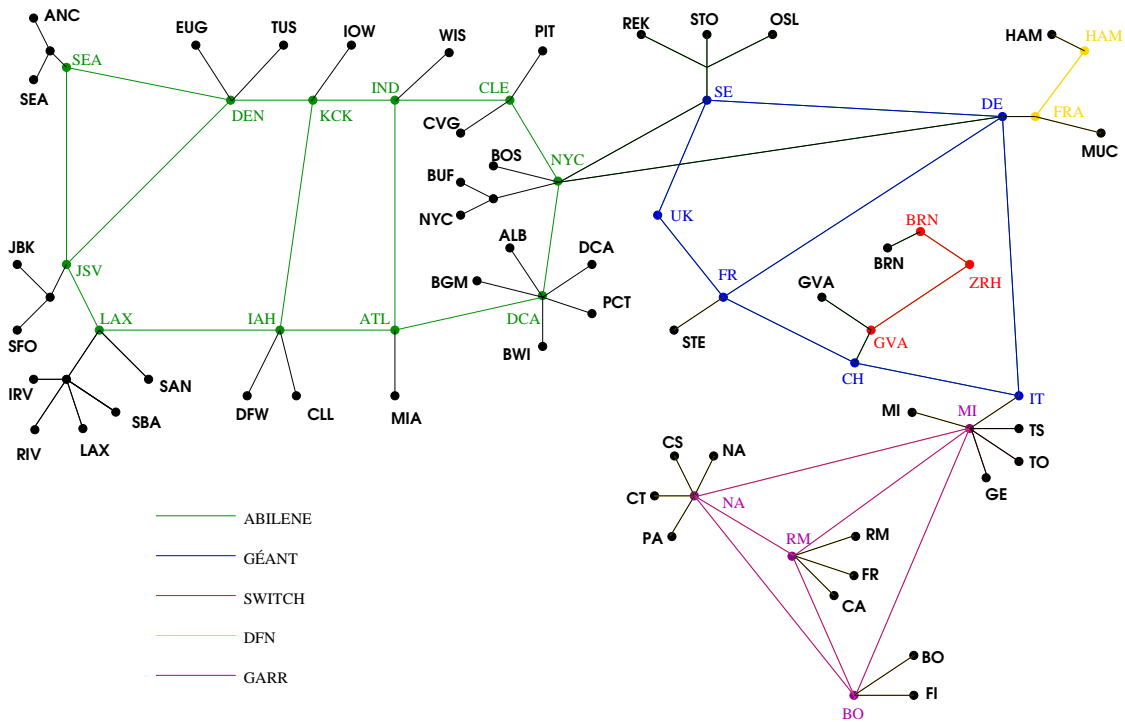

Figure 6.4: The ns-2 simulation topology.

7 Simulation Setup

The goal of the simulations was to evaluate the performance of Multicast for Small Conferences against native multicast mechanisms. In order to obtain information about MSC's sensitivity to group size and clustering, a number of different setups (sets of end systems) were defined. All of these were used with several different MSC configurations as well as native multicast and naive unicast. The simulations are based on the idea of using MSC for an audio conference, i.e. with relatively small packet sizes (see 7.2) and a limited tolerance to delays.

7.1 Simulation parameters

7.1.1 Group size

Group size is probably the most obvious parameter to use. Theoretically, this parameter is expected to have a significant effect on the overall performance of the MSC protocol in terms of delay and bandwidth usage, particularly when end system MSC is used, i.e. the packet is forwarded from one receiver to the next. However, the influence of the group size on the delay can be expected to be reduced with the introduction of MSC capable routers. The amount of additional bandwidth consumption caused by larger groups due to the larger routing header obviously depends on the clustering (i.e. the spatial locality of the group). In the scenarios of this performance simulation, five different group sizes are used: 4, 8, 12, 16 and 20. On the lower end, four makes sense because it is almost the smallest possible group. At the same time a formation of 16 or 20 hosts can hardly be called a *small* conference and should thus be suitable for testing the performance limit of the MSC protocol.

7.1.2 Clustering

Clustering denotes the spatial locality of a group. The stronger the clustering, the closer the members of a conference are together (in the network topology). Three strengths of clustering were used in the simulation:

None In these scenarios an even distribution of the involved hosts over the whole simulation topology was envisaged. For small group sizes this means one to two hosts per backbone network. In environments with a larger number of end systems the idea was to have no more than one host per backbone router.

Strong In simulations with strong clustering the end systems are divided into two to four clusters of two to five hosts (depending on the group size). A cluster is a number of end systems connecting to the same backbone router.

Weak The idea of weak clustering is to choose the end systems in a way that the distribution is somewhere inbetween the two degrees of clustering listed above.

As mentioned in the previous section, clustering is expected to have a significant impact on the performance of the MSC protocol both in terms of delay and bandwidth consumption, especially in scenarios with end system MSC.

CL	GS	Hosts
None	4	BRN, FI, OSL, DFW
None	8	BRN, FI, OSL, DFW, CS, HAM, JBK, PIT
None	12	BRN, FI, OSL, DFW, CS, HAM, JBK, PIT, GE, SEA, ALB, TUS
None	16	BRN, FI, OSL, DFW, CS, HAM, JBK, PIT, GE, SEA, ALB, TUS, STE, SBA, MIA, WIS
None	20	BRN, FI, OSL, DFW, CS, HAM, JBK, PIT, GE, SEA, ALB, TUS, STE, SBA, MIA, WIS, FR, SAN, BUF, IOW
Weak	4	MI, BO, SAN, DFW
Weak	8	MI, BO, SAN, DFW, BRN, GVA, BOS, CVG
Weak	12	MI, BO, SAN, DFW, BRN, GVA, BOS, CVG, ALB, PCT, TUS, EUG
Weak	16	MI, BO, SAN, DFW, BRN, GVA, BOS, CVG, ALB, PCT, TUS, EUG, FR, STE, CLL, NYC
Weak	20	MI, BO, SAN, DFW, BRN, GVA, BOS, CVG, ALB, PCT, TUS, EUG, FR, STE, CLL, NYC, GE, SBA, SEA, PIT
Strong	4	MI, TS, IRV, RIV
Strong	8	MI, TS, IRV, RIV, SBA, ALB, BGM, DCA
Strong	12	MI, TS, IRV, RIV, SBA, ALB, BGM, DCA, RM, NYC, BUF, BOS
Strong	16	MI, TS, IRV, RIV, SBA, ALB, BGM, DCA, RM, NYC, BUF, BOS, CA, JBK, SFO, SAN
Strong	20	MI, TS, IRV, RIV, SBA, ALB, BGM, DCA, RM, NYC, BUF, BOS, CA, JBK, SFO, SAN, GE, PCT, PIT, CVG

CL:

Clustering

GS: Group Size

Table 7.1: Topology scenarios based on the topology in Figure 6.4

Obviously, the 15 basic scenarios are somewhat arbitrary, since there are no definite criteria for choosing the set of end systems. But since all simulations are based on the same set of nodes the influence on the results should be negligible.

7.1.3 MSC router functionality

The combination of the previously described parameters (group size and clustering) results in 15 scenarios (sets of end systems), shown in Table 7.1. These are used for simulations in several configurations with varying degrees of multicast or MSC functionality (an overview is given in Table 7.2):

Native multicast In this configuration, the data is forwarded between end systems using native multicast mechanisms. The two different types of multicast supported by ns-2.1b8 have been presented in section 4.5. For these reference simulations, Centralized

Multicast with Rendezvous Points at all end systems was used. This is not a sensible assumption in the real-world; however, it does make sense for this simulation, as it results in an optimal multicast packet delivery tree. This configuration thus represents the best setup (theoretically) achievable with native multicast mechanisms and does not include any effects caused by overhead such as packet encapsulation (Centralized Multicast) or network flooding (Dense Mode).

Naive unicast There is no multicast or MSC functionality present in this configuration. The involved end systems just communicate via unicast, i.e. a sender produces a unicast packet for each recipient. This obviously yields the lowest possible delays, but suffers from extremely high bandwidth consumption, combined with high link stress.

End system MSC This setup differs from naive unicast in that the involved end systems are MSC capable. As a result, each packet is forwarded between all receiving end systems. Each host examines the addresses in the routing header and forwards the packet to the nearest one.

Full-scale MSC In addition to the MSC functionality deployed in the end systems, all routers in the backbone networks are standard MSC capable.

MSC at backbone interlinks Instead of having MSC functionality in all nodes (which would be costly to achieve in the real world), only a few routers are MSC capable. In this scenario, these are placed on the nodes that have a link to another backbone network (Figure 7.1). As in all MSC scenarios, the end systems are MSC capable. The result is an uneven distribution of the routers. For example, four of the six Géant nodes are MSC capable, while only one in the larger Abilene network has this functionality.

EMSC at backbone interlinks The only difference between the MSC at backbone interlinks and the EMSC at backbone interlinks scenarios is that the latter uses enhanced MSC capable routers instead of standard MSC routers. The goal is to find out if the increased complexity of enhanced MSC pays off, i.e. if it can outperform standard MSC in an “intermediate” scenario.

MSC SIX As in the previous two setups, only a few nodes have MSC functionality. In this case however, the six MSC routers (as opposed to eight in (E)MSC at backbone interlinks) are more evenly distributed over the topology. Three are placed in the large Abilene network, while three serve Géant and the European backbone networks (Figure 7.2). The interlink concept is retained in that the routers on the transatlantic links (AbileneNYC, GéantSE and GéantDE) are MSC capable. Comparing the results of this scenario to the performance of full-scale MSC could indicate whether gradual deployment of MSC is possible. Also, a comparison with MSC at backbone interlinks should give an idea of the effect of router distribution on the performance of Multicast for Small Conferences.

EMSC SIX Similar to EMSC at backbone interlinks, this setup is used to determine performance differences between standard and enhanced MSC. The same routers as in the MSC SIX scenario possess MSC capability.

While all of the configurations listed above use either native multicast, unicast or the new Multicast for Small Conferences approach, it would also be interesting to evaluate the performance of a mixed scenario. In such a setup, MSC would be used for the backbone traffic,

7 Simulation Setup

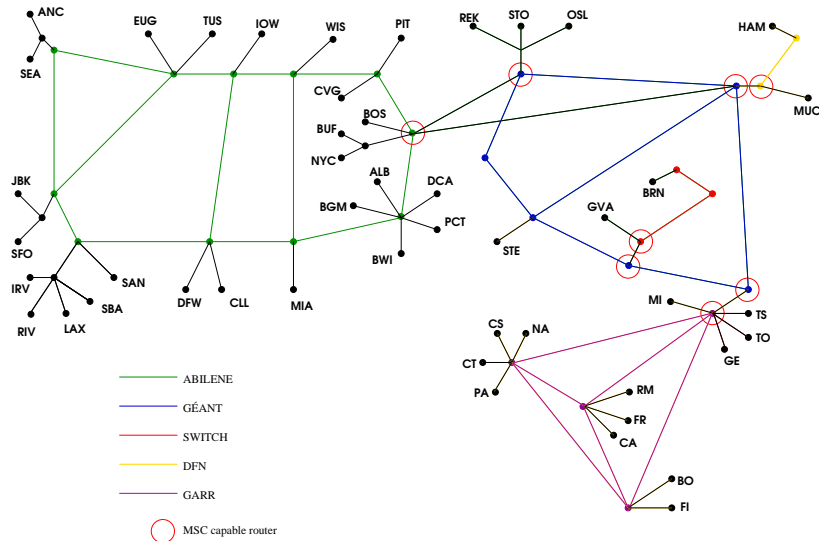

Figure 7.1: Backbone at interlinks configuration

while the gateways serving the end systems could use native multicast in the access networks. However, these tests would require a much larger topology with a detailed reproduction of the access networks and thus massively increase the complexity of the simulation. Furthermore, detailed information about the structure (topology) and characteristics (delays, routing) of the networks to which the end systems connect would be required.

7.2 Packets

All configurations described in the previous section were run in ns-2 for all fifteen base topology scenarios. In each simulation run, the involved end systems consecutively send a single packet to the rest of the group (except for naive unicast). The simulation software records the

Configuration	MSC capable routers
Native multicast	none
Naive unicast	none
End system MSC	none
Full-Scale MSC	all 25 backbone routers
MSC at backbone interlinks	NYC, SE, DE, CH, IT, FRA, GVA, MI
EMSC at backbone interlinks	NYC, SE, DE, CH, IT, FRA, GVA, MI
MSC SIX	NYC, LAX, KCK, DE, CH, MI
EMSC SIX	NYC, LAX, KCK, DE, CH, MI

Table 7.2: Configurations based on the topology in Figure 6.4. For MSC at backbone interlinks and MSC SIX also see Figures 7.1 and 7.2

7 Simulation Setup

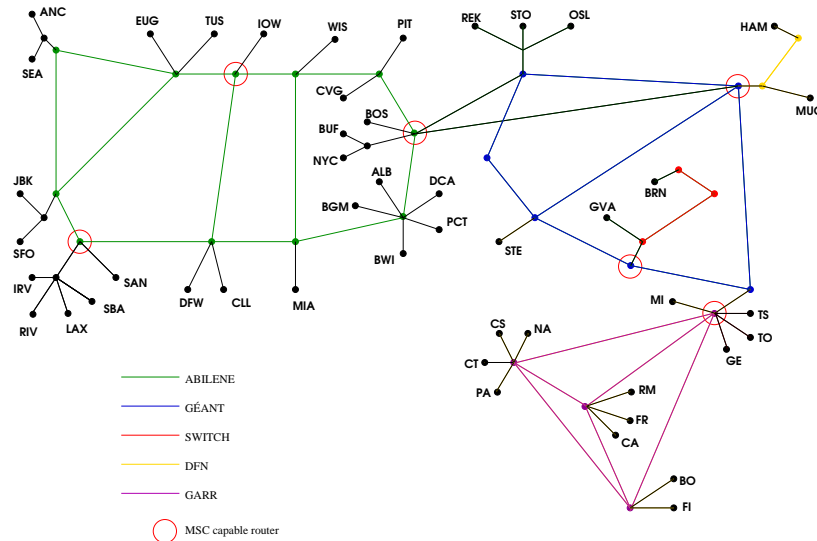

Figure 7.2: MSC SIX/EMSC SIX configuration; for EMSC simulations, the domains are set as colored, i.e. each backbone network is considered a domain

arrival and departure times as well as the size of each packet at all nodes and on all links. The packet size used in the simulations of this performance evaluation is based on a scenario where Multicast for Small conferences is used for an audio conference. Supposing end systems using ISDN, a data-rate of 64 kbit/s is assumed. If packets are sent every 10 milliseconds, each packet contains 80 bytes of data (payload). On the application level, the data flow can be controlled by the Real-Time Protocol (RTP) [25]; this adds a minimum of 12 bytes (RTP header) to the packet size. As for the transport layer, the use of the User Datagram Protocol (UDP) [22] is probable. For transmission over IPv6, UDP uses packet headers of 40 bytes, consisting of 16 bytes for the source and destination addresses respectively and a total of 8 bytes for packet length, checksum and next header information. In the network, the packets will be forwarded using IPv6. The standard IPv6 header has a length of 40 bytes, bringing the overall packet size to 172 bytes. This is the packet size that is applied for native multicast and unicast simulations. When using MSC, a routing header carrying the group's multicast address is present at all times, adding another 32 bytes (16 bytes for the routing header overhead and 16 bytes for the multicast address), resulting in the minimum packet size of 204 bytes.

80 bytes	audio data (payload)
12 bytes	RTP header
40 bytes	UDP header
40 bytes	IPv6 header
<i>172 bytes</i>	<i>not MSC related</i>
16 bytes	IPv6 routing header overhead
16 bytes	Multicast address carried in the routing header
<i>32 bytes</i>	<i>by MSC specification</i>
204 bytes	Total

This packet size would be observed in a scenario with just two participants (source and destination); obviously using a multicast address is useless in this case. Usually, more than one recipient would be present, and the unicast addresses (16 bytes each) of the additional group members would be carried in the routing header, increasing the packet size.

As already discussed briefly in section 3.4 this increase of the size of the routing header can massively deteriorate the overhead/payload ratio, especially for small packets such as in this audio conference scenario.

7.3 Metrics

As already mentioned in section 7.2, each simulation is set up the same way: Every involved hosts sends a packet to the group. This obviously results in quite a lot of data stored in the tracefiles. For scenario-specific analysis this data is aggregated into just four values that can be used to assess the performance of MSC:

Maximum Delay The maximum delay found in a scenario can be used to decide whether audio conference is feasible with the selected parameters. Usually, a maximum delay of 100 or 150 milliseconds is used as a threshold. Ideally, all values should be below that limit.

Average Delay The average of all sender-receiver delays measured in a scenario is an indication of the overall performance in the given configuration. The average value should usually remain well below the threshold for the maximum delay.

Bandwidth Consumption For this performance evaluation, the overall link usage is used as a metric for bandwidth consumption. This means that the bytes transported on each link are recorded in the tracefile, and these values are summed up on a per-scenario basis to result in a comparable figure.

Backbone Usage The backbone usage parameter uses the same data as bandwidth consumption; however, only bytes transferred on links in backbone networks (Géant, Abilene, Garr, Switch, DFN) are taken into account. The sum of these is then divided by the overall bandwidth consumption, resulting in a comparable percentage. This parameter differs from the other three in that it is not downright clear whether a high or low value is good or bad. However, approaches that exonerate the access networks (i.e. that have a high backbone usage) are usually favored.

8 Results

The following sections contain the results of 120 simulation runs (8 configurations with 15 scenarios each) as diagrams. Each figure contains the results of a single metric (e.g. average delay) for a specific degree of clustering. For each metric, the three diagrams have the same scale. Values are presented for all eight configurations and all fivegroup sizes. The lines connecting the data points are only shown to facilitate the interpretation and should not be overrated.

8.1 Average delays

The most outstanding characteristic of the diagram shown in Figure 8.1(a) is the massive performance difference between end system MSC and the other configurations. This phenomenon is seen in all delay-related results; however, it is most distinctive when spatial locality is low (i.e. weak clustering). Also, the performance gap widens as the group size increases. While most configurations see only a marginal (or even no) increase in average delays when new hosts are added, the values for end system MSC increase linearly.

An ostensible oddity is the fact that the MSC SIX and EMSC SIX average delays for a group with 20 hosts are lower than their respective values for group size 16. The reason for this effect is that the additional four end systems (FR, SAN, BUF, IOW) lie close to MSC routers in these configurations and are thus served very efficiently. The resulting low delays for traffic from and to these hosts reduces the average delay. Unsurprisingly, the simulations for weak and strong clustering (shown in Figures 8.1(b) and 8.1(c)) illustrate that the absolute average delays are decreasing as the clustering gets stronger (i.e. end systems are closer together). However, a massive difference between end system MSC and the other configurations remains.

As already seen in Figure 8.1(a), the average delays sometimes decrease as groups grow. In scenarios with stronger clustering this effect is not only caused by the proximity of additional end systems to MSC capable routers. The newly introduced hosts are deliberately placed close to already used nodes to maintain a high degree of clustering. This causes low end-to-end delays even when no MSC functionality is involved (i.e. packets are forwarded between end systems) and thus can reduce the average delays.

8.2 Maximum delays

The performance gap between end system MSC and the configurations seen in the average delays also exists with the maximum delay parameter (Figures 8.2(a), 8.2(b) and 8.2(c)). Again, the extent of the difference depends on the spatial locality. When the hosts are closer together (i.e. in groups of two to five), end system MSC benefits superproportionally. Also,

8 Results

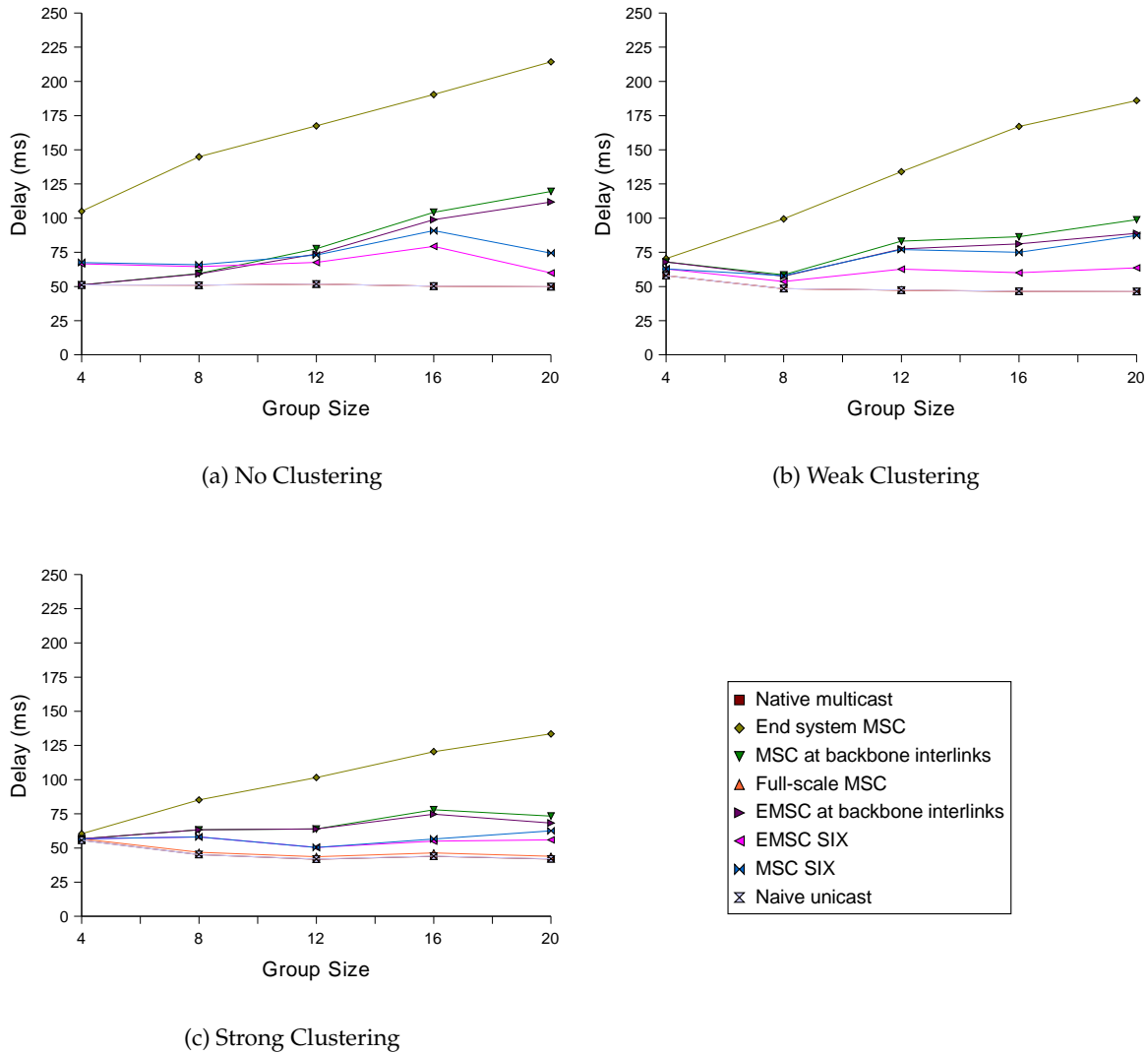

Figure 8.1: Average Delays

the other approaches do not all perform equally here. Native multicast and naive unicast show consistently low maximum delays, while other configurations, particularly (E)MSC at backbone interlinks, suffer from higher maximum delays as group sizes increase. There are a few cases where the maximum measured delay decreases as the group size increases, e.g. in the EMSC SIX configuration with weak clustering. The explanation of this effect is based on router distribution. When a new end system is introduced, the forwarding path of a packet from a given sender to the receivers may be changed, since the senders order the recipient's addresses by distance. In some configurations, the new sequence (and the resulting forwarding path) is much more efficient, for example because an MSC capable router is encountered earlier in the forwarding process. This in turn can lead to completely different, potentially significantly lower end-to-end delays.

This effect and a similar occurrence in average delays highlight the impact that the selection

of end systems (i.e. the composition of a multicast group) can have on the performance of multicast mechanisms.

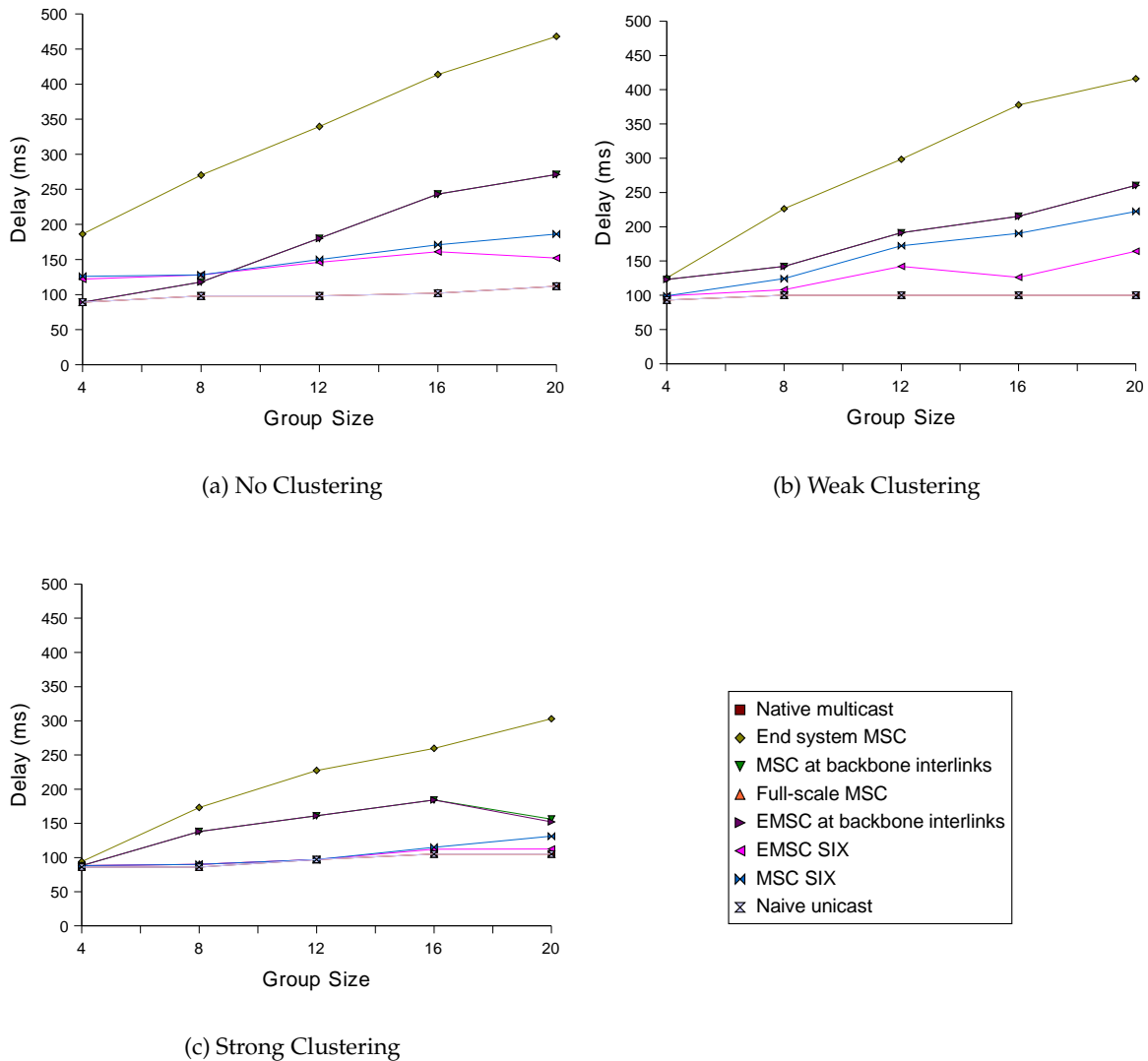

Figure 8.2: Maximum Delays

8.3 Bandwidth consumption

As could be expected, the bandwidth consumption in scenarios with low spatial locality of the end systems (Figure 8.3(a)) is significantly higher than with hosts that form clusters (Figures 8.3(b) and 8.3(c)). This can be seen as an indication that the different sets of end systems used to represent the three degrees of clustering were chosen appropriately. As with the average and maximum delay parameters, the bandwidth consumption among the eight configurations increase when group sizes increase. While the link usage of native multicast

8 Results

increases almost linearly, it does so exponentially for some of the other approaches, particularly naive unicast and end system MSC. This is a good indication of the scalability problems of end system-based mechanisms.

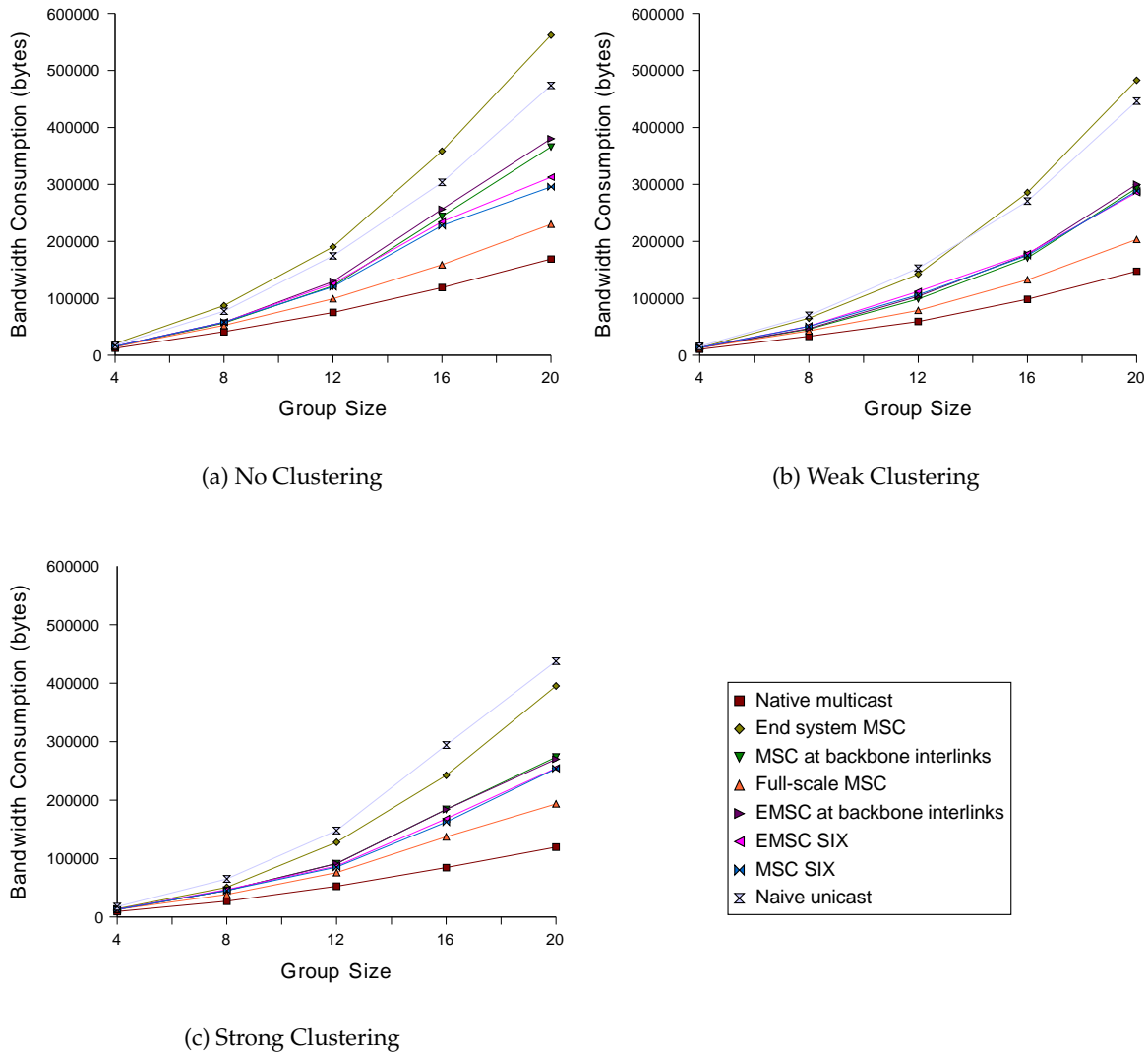

Figure 8.3: Bandwidth Consumption

8.4 Backbone usage

The trend of increasing differences with increasing group sizes is also noticeable in the diagrams showing the backbone usage. Also, clustering again has a tremendous effect on the result. But while the performance gap narrows with increased clustering for the delays and bandwidth consumption, it widens in terms of backbone usage. With high spatial locality (Figure 8.4(c)), some approaches are very sensitive to group size, showing a massive de-

crease in backbone usage as hosts are added, e.g. end system MSC or native multicast. In the case of end system MSC this is due to excessive packet forwarding between end systems, which most affects the links close to the hosts. For native multicast, the explanation is different. The backbone usage is relatively high for small groups (especially with low clustering), since each destination is served using an optimal forwarding path. This drives up the number of backbone links that have to carry the packet, while the number of used access network links is low. When new receivers are added, the core of the forwarding tree doesn't change very much, especially with strong clustering. Thus the load on the backbone links will not increase significantly. This is further emphasized by the fact that packet size is independent from group size (unlike in MSC scenarios). However, some new access network links are added to the forwarding tree, adding bytes to the non-backbone counter and thus reducing the backbone usage.

At the same time naive unicast shows almost constant values for all group sizes and only marginally reacts to changes in clustering. The reason is simple: With the naive unicast approach, each packet travels all the way from the sender to the receiver, using backbone and access networks. In the other configurations, the senders produce less packet copies and instead rely on packet forwarding between end systems, which drives up the usage of access networks, especially when the clients are strongly clustered.

Another interesting aspect is the performance of (E)MSC at backbone interlinks and (E)MSC SIX. While the MSC and EMSC approaches show almost identical results in terms of bandwidth consumption (Figures 8.3(a), 8.3(b) and 8.3(c)), they have completely different values for backbone usage. The enhanced MSC approaches consistently show higher values than the standard MSC concepts. Also, the differences increase with group sizes and are most distinctive when clustering is low.

8 Results

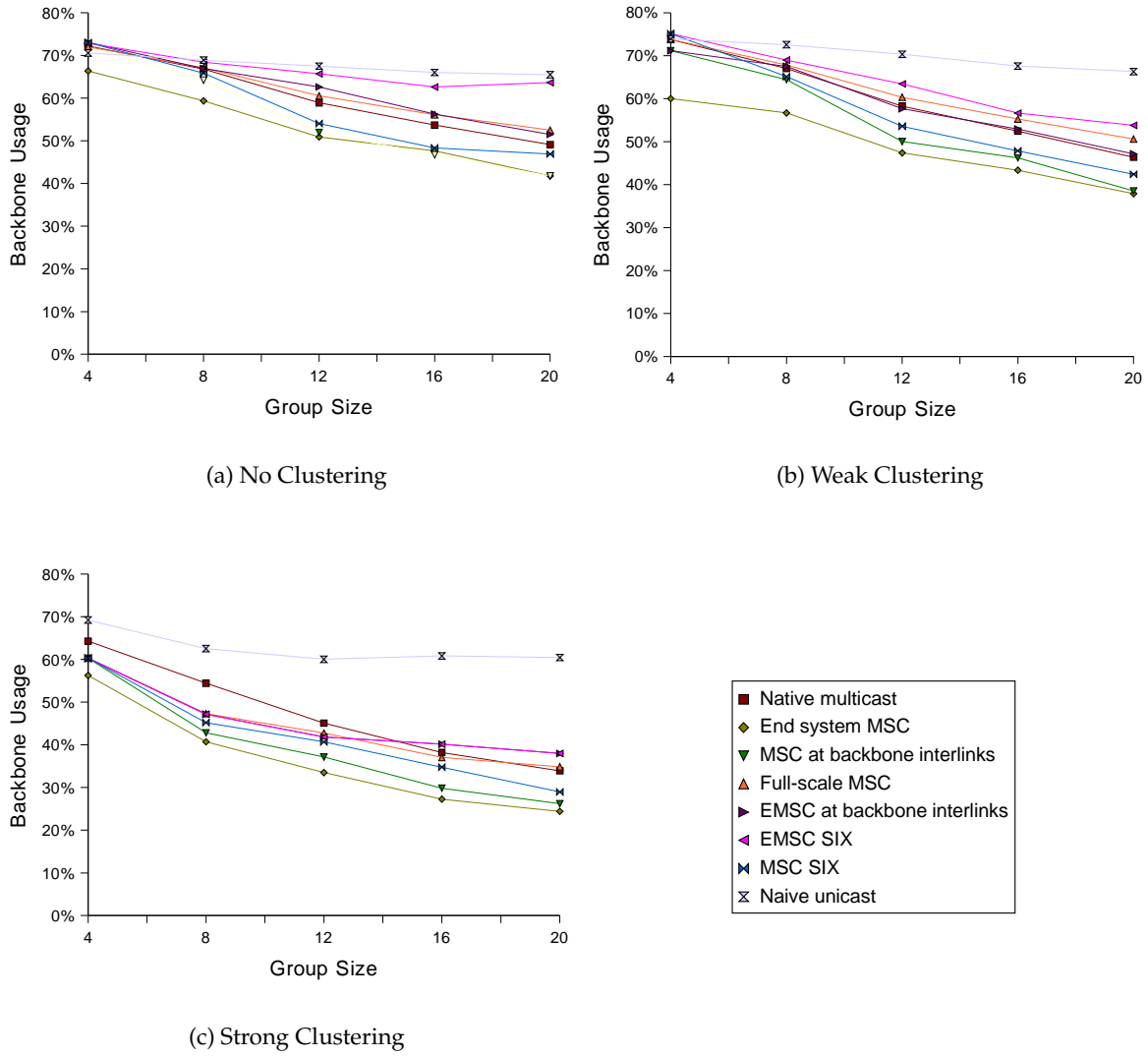

Figure 8.4: Backbone Usage

8.5 Summary

The following parameters are listed in the summaries of the results (Tables 8.1, 8.2, 8.3).

RDP: Relative Delay Penalty The ratio of the MSC delay between two hosts to the IP Multicast delay between them: $\frac{MSC\ delay}{IP\ Multicast\ delay}$

EXD: Excess Delays Percentage of delays above 150ms in a setup (all 15 scenarios).

NRU: Normalized Resource Usage Ratio of the link usage relative to link usage of native multicast. It should be kept in mind that the difference in bandwidth consumption between MSC configurations and native multicast is partially caused by the longer IP header. If the packet (payload) length were increased from the relatively small 80 bytes used in this simulation, the impact of the longer header would be reduced, resulting in a lower NRU. Also, an over-optimized native multicast mechanism is used in this study.

BBU: Backbone Usage The percentage of link usage that involves links of backbone networks.

Configuration	RDP min	RDP max	RDP avg	EXD
Native multicast	1	1	1	0%
Naive unicast	1	1	1	0%
End system MSC	1.1	4.3	2.7	44%
Full-scale MSC	1	1.1	1	0%
MSC at backbone interlinks	1	2.4	1.6	15%
EMSC at backbone interlinks	1	2.2	1.5	14%
MSC SIX	1	1.9	1.4	6%
EMSC SIX	1	1.6	1.3	1%

Table 8.1: Summary of Relative Delay Penalties (RDP) of the average delays, and percentage of delays >150ms

Configuration	NRU min	NRU max	NRU avg
Native multicast	1	1	1
Naive unicast	1.4	3.7	2.5
End system MSC	1.3	3.3	2.4
Full-scale MSC	1.2	1.6	1.4
MSC at backbone interlinks	1.3	2.3	1.8
EMSC at backbone interlinks	1.3	2.3	1.8
MSC SIX	1.3	2.1	1.7
EMSC SIX	1.3	2.1	1.7

Table 8.2: Summary of Normalized Resource Usage (NRU)

8 Results

Configuration	BBU % min	BBU % max	BBU % avg
Native multicast	34	74	56
Naive unicast	60	74	67
End system MSC	24	66	46
Full-scale MSC	35	74	56
MSC at backbone interlinks	26	72	50
EMSC at backbone interlinks	32	73	54
MSC SIX	29	75	52
EMSC SIX	38	75	59

Table 8.3: Summary of Backbone Usage (BBU) percentage

9 Performance Evaluation

While the previous chapter has given an overview of the simulation results by briefly discussing the results on a per-parameter basis, this chapter provides a more detailed analysis of the results of each configuration. It also highlights the performance differences between MSC configurations and native multicast as well as between the different MSC setups, providing the basis for the conclusions presented in chapter 10.

9.1 Native multicast

The results of this configuration form the basis of the performance evaluation. A few things are noteworthy: In terms of delay, native multicast is insensitive to group size and clustering, since packets are always forwarded along an optimal tree. But even with this “perfect” routing some end-to-end delays are in excess of 100 milliseconds (but none are >150ms).

The bandwidth consumption of native multicast is low, since it never unnecessarily duplicates packets. However, group size and clustering affect the results: link usage increases linearly as groups grow, and the gradient depends on the spatial locality of the hosts. Since the addition of hosts does not affect backbone links that are already part of the multicast delivery tree, the backbone usage decreases as groups grow.

Unsurprisingly, none of the alternative approaches can beat native multicast’s performance. But as has been pointed out in the introduction, native multicast burdens Internet routers by increasing the routing table sizes.

In terms of backbone usage, two things are noteworthy: Firstly, native multicast has a relatively high backbone usage compared to the MSC approaches. The reasons for this have already been pointed out in section 8.4: optimal forwarding paths and lack of packet forwarding between end systems. Secondly, the values increase significantly (and almost linearly) as group size increases. The reason for this is IP Multicast’s efficiency: packets are never duplicated over the same link. Thus, the addition of a new end systems doesn’t necessarily burden the backbone, especially when clustering is strong (i.e. the end systems are close together).

9.2 Naive unicast

Like native multicast, naive unicast is included in this performance study as a basis for comparison. While the concepts of native multicast and naive unicast share the advantage of low end-to-end delays, they differ significantly in bandwidth consumption. Depending on group size and clustering, naive unicast uses 1.4-3.7 times the bandwidth of native multicast. Also, naive unicast suffers from high link stress, i.e. a lot of identical packet copies are sent over the same links. The last two points highlight why naive unicast is no option for

replacing IP Multicast.

Naive unicast has very high and almost constant backbone usage values. This is no surprise as each packet travels the whole way from the sender to the receiver.

9.3 End system MSC

Unsurprisingly, end system MSC suffers from very high delays due to the packet forwarding between receiving end systems. End-to-end delays increase linearly with group size, as opposed to native multicast or naive unicast where they remain almost constant. Also, this concept is sensitive to clustering: Strong clustering means the receivers are close together, which significantly reduces the delay caused by forwarding between receivers. Consequently, end system MSC shows a good performance for small groups and strong clustering, but suffers from a massive increase in average and maximum delays as group size increases and clustering is reduced. 44% of all measured delays in the 15 scenarios exceed the 150ms threshold (the maximum being 468ms), proving that end system MSC is not feasible.

In terms of bandwidth consumption, end system MSC also shows a poor performance. For very small groups, link usage is only about 20% higher than for native multicast. But while bandwidth consumption increases linearly for native multicast, it grows exponentially in the case of end system MSC. For a group of 20 hosts and no clustering, the sum of all transferred data bytes is 3.3 times that of native multicast. The range of values (for bandwidth consumption) is about the same as that of naive unicast, but the two concepts do not perform identically. End system MSC is better than naive unicast in scenarios with strong clustering since it does not have to send duplicate packets over the same link. But when spatial locality is low, naive unicast can outperform end system MSC since the latter suffers from longer forwarding paths between the receivers.

End systems MSC consistently shows the lowest backbone usage percentage of all eight configurations. This is also due to the packet forwarding between receiving end systems, as this forwarding mainly takes place in the access networks. With strong clustering and large groups, backbone usage even drops below 30%, indicating that end system MSC heavily burdens the networks close to the recipients.

9.4 Full-scale MSC

The MSC router functionality on all nodes in the backbone networks results in optimal forwarding paths and reduces packet forwarding between end systems to a minimum. This shows in almost no delay penalty compared to native multicast and naive unicast. Also, full-scale MSC is insensitive to group size and clustering.

In terms of bandwidth consumption full-scale MSC cannot keep up with native multicast due to the routing header (which increases the packet size) and occasional forwarding between end systems that are connected to the same backbone router (e.g. between SFO and JBK). Overall, the bandwidth consumption is 120%-160% that of native multicast. The upper boundary of this range is reached with stronger clustering, when packet forwarding between end nodes increases. However, it should be kept in mind that a perfect native multicast model is used.

The backbone usage data of full-scale MSC show no particular high or low values. Backbone usage decreases with increasing group sizes, but the decline is much less dramatic than

in other configurations (e.g. MSC at backbone interlinks).

9.5 MSC at backbone interlinks

In terms of average and maximum delay, this scenario performs significantly better than end-system MSC. Unfortunately it also performs significantly worse than full-scale MSC or native multicast. The results are satisfactory in scenarios with small groups (four or eight hosts), but with increasing group sizes the uneven distribution of MSC functionality and the resulting packet forwarding between end systems in the Abilene part of the simulation network severely deteriorates the performance. Overall, the delays are up to 2.3 times those of native multicast. The absolute maximum delay exceeds the 150ms threshold in all simulations with 12 or more hosts.

With MSC at backbone interlinks, bandwidth consumption is 1.3-2.3 times that of native multicast, depending on group size and degree of clustering. Similar to the other configurations, MSC at backbone interlinks' efficiency is best when groups are small and spatial locality is high.

The backbone usage of this approach is inconsistent. For small groups (and particularly in combination with low clustering), MSC at backbone interlinks performs as well as other configurations, e.g. full-scale MSC. But as group sizes increase, the percentage decreases at a high rate and almost drops to the levels of end system MSC.

Altogether, the performance of this concept indicates that acceptable results are achievable with just a small number of MSC capable routers.

9.6 EMSC at backbone interlinks

The delay performance of EMSC at backbone interlinks is very similar to that of the corresponding setup using standard MSC. The former shows marginally lower average delays in scenarios with large groups, due to the reduced packet forwarding in the Abilene part of the topology (since packet copies per egress router are created). The difference is even smaller in scenarios with strong clustering, since they inherently require less packet forwarding, which benefits standard MSC.

The bandwidth consumption of the two interlink approaches is almost equal, with minimal advantages for standard MSC when clustering is low and similar disadvantages for the same concept when end systems lie close together. While EMSC suffers from duplicate packets sent over the same link, standard MSC needs to perform more packet forwarding between end systems, and the two effects seem to cause identical performance penalties. However, a shift in network loads is visible: Enhanced MSC creates more traffic inside the backbone networks while exonerating the access networks. For both approaches, the amount of transported bytes on backbone links is over 70% in scenarios with small groups and low clustering. This value decreases as groups grow and spatial locality increases. Increased group sizes require the use of more access network links, while increased clustering reduces the number of used backbone links. The decrease is significantly stronger with standard MSC than with enhanced MSC, reaching a minimum of 26% and 32% respectively (Table 8.3).

There are two reasons for this interesting effect:

- With enhanced MSC, the first router encountering an MSC packet produces copies for

all egress routers. Thus, the probability is high that some links will transport more than one packet copy. This in turn increases the backbone link usage.

- Once a packet copy for each egress router is created, no receiving end system will have to forward an incoming packet to a host outside the access network, as these systems have different egress routers and thus receive another packet copy. This reduces both the bandwidth usage in the access network (back to the egress router) as well as in the backbone (between the egress routers).

The same effect was observed in the MSC SIX and EMSC SIX configurations (see next sections).

9.7 MSC SIX

As indicated in section 7.1.3, the MSC SIX configuration is aimed at improving the results of the MSC at backbone interlinks configuration through better router distribution.

In terms of delay, some improvement is noticeable: While there are still some delays of up to 1.9 times the value of native multicast, the number of delays in excess of 150ms could be reduced significantly. Just 6% of all measured delays exceed the threshold, as opposed to 15% for MSC at backbone interlinks. High delays are only measured for larger groups (12 or more hosts) with weak spatial locality. The maximum delays are also lower, with only a single value in excess of 200ms.

Bandwidth consumption is affected similarly: The overall link usage is 1.3-2.1 times that of native multicast, i.e. similar to MSC at backbone interlinks. For most group size/clustering combinations however, bandwidth consumption is slightly reduced compared to the previous configuration.

The backbone usage of the two concepts differs only marginally, with the MSC SIX configuration consistently showing higher values (usually 2-3%, max. 5%).

These results (and the performance of MSC at backbone interlinks) prove that MSC can deliver an acceptable performance with just a few MSC capable routers, at least for smaller groups, even with widely spread group members. Compared to full-scale MSC, lower deployment costs (i.e. using just six or eight MSC routers instead of 25) have been traded against higher delays and increased bandwidth consumption.

The comparison of MSC SIX against MSC at backbone links, in particular the significant difference in delays in excess of 150ms, proves that router distribution is critical.

9.8 EMSC SIX

The end-to-end delays measured in this configuration are slightly lower than those of MSC SIX, and the performance gain is increasing with larger group sizes and when clustering is reduced. In the latter case the duplication of packets (one per egress router) over the same link pays off. Compared to the previous configuration, the amount of delays in excess of 150ms could again be reduced, to just 1%.

In terms of bandwidth consumption there is only a marginal difference between MSC SIX and EMSC SIX. The additional link usage caused by the duplication of packets over the same link is almost completely compensated for by the elimination of some packet forwarding between receiving end systems. As already pointed out in section 9.6, the EMSC approaches

show significantly higher values in backbone usage than the standard MSC concepts. This is true in (E)MSC SIX as well, with minima of 29% and 38% reached respectively. Again, the additional link usage caused by the duplication of packets over the same link is almost completely compensated for by the elimination of some packet forwarding between receiving end systems.

9.9 Comparison of MSC and native multicast

In terms of delays, MSC can only achieve the same performance as native multicast when full-scale MSC is used (i.e. all routers are MSC capable). This, however, would be costly to achieve in the real-world. With an optimized “intermediate” approach such as in the (E)MSC SIX scenarios, a delay penalty of up to 90% (60% with enhanced MSC) has to be accepted (Table 8.1). However, depending on the scenario parameters (group size, clustering), the difference to native multicast may be significantly smaller. With a different, less optimal router distribution such as in the (E)MSC at backbone interlinks scenarios, RDP values of up to 2.4 have been observed. It is doubtful whether a delay-sensitive application could be supported in such a configuration.

The bandwidth consumption of native multicast is unbeatably low. Due to the longer IP header, packet duplication and packet forwarding between end systems, MSC always has a higher link usage than native multicast. Even in a full-scale MSC configuration the Normalized Resource Usage (NRU) is between 1.2 and 1.6 (Table 8.2). With only a few capable routers ((E)MSC at backbone interlinks, (E)MSC SIX), the bandwidth consumption can even be more than twice that of a native multicast approach serving the same end systems. With the higher backbone usage of enhanced MSC (Table 8.3) it should at least be possible to limit the additional strain on the access networks.

10 Summary

The performance evaluation performed as part of this thesis has highlighted the potential of Multicast for Small Conferences. Particularly, it has shown that with just a small number of dedicated routers the delay penalty compared to native multicast mechanism can be kept relatively low (factor two). The same is true for bandwidth consumption, where even better results should be achievable with increased packet (i.e. payload) size.

The simulation results and their interpretation in the previous chapter also provide the basis for a number of conclusions about the concept of Multicast for Small Conferences:

1. **End system MSC is not feasible.** As has been shown in section 9.3, end system MSC produces unacceptably high delays in almost all scenarios. Given the 150ms delay limit, supporting audio or video conferences is only possible for very small groups with strong spatial locality. This does *not* mean that end system multicast does not work. It merely proves that end system multicast on IP level without router support cannot deliver the performance required to support delay-sensitive applications. A possible solution is the use of an application-level multicast scheme, some of which have been presented in section 2.2. However, it seems as if only Narada [16] could provide the required performance, at the cost of increased bandwidth consumption and link stress.
2. **Only a small number of MSC capable routers is required to significantly improve the performance.** The tremendous difference in the results of the end system MSC and MSC at backbone interlink scenarios impressively proves this point. Two things can be deduced:
 - **There is no need for full-scale MSC.** A very good performance can be delivered with just a few MSC capable routers at considerably lower deployment costs.
 - **Gradual MSC deployment is possible.** Assuming the availability of appropriate end systems, MSC can start at a low performance level with no or very few dedicated routers. Performance can then be gradually improved through the deployment of additional MSC routers.
3. **MSC router distribution is critical.** The fact that the MSC SIX configuration (with its more evenly distributed routers) yields better results than the MSC at backbone interlink setup is a good indication of this. It is tempting to place MSC routers on nodes where backbone networks connect, particularly because these nodes have a high traffic load. However, with several members of a group connecting to the same backbone network (or even the same router), this approach can result in high delays as packets are forwarded between end systems without encountering an MSC router. When developing rules for MSC router placement, two things should be kept in mind:

- The (potential) performance of a *standard* MSC router depends on the number of outgoing interfaces. The more packet copies a standard MSC router can create (at most one per outgoing link), the less addresses remain in the various routing headers, reducing the necessary forwarding between end systems accordingly. In contrast, the performance of *enhanced* MSC routers is not affected by the out-degree of the node, as the number of packet copies created only depends on the number of egress routers involved.
- Once an MSC packet has been processed by an enhanced MSC capable router the optimal forwarding strategy through that domain is executed for all destination addresses. Thus, enhanced MSC is most effective when MSC packets are intercepted as early as possible after entering a certain network domain. This is not necessarily true for *standard* MSC, since the routers have no knowledge of possible branching further down the forwarding tree.

Unfortunately these two rules alone do not guarantee a good performance. For example, a standard MSC router with a lot of outgoing links won't be helpful if the relevant traffic bypasses the node. On the other hand, trying to intercept all packets entering a domain as early as possible would almost certainly result in full-scale MSC. Thus, a compromise has to be found. The most obvious solution is to distribute the MSC functionality as evenly as possible over the entire network. This maximizes the probability that a packet encounters an MSC router, thus reducing the potential for packet forwarding between end systems. The performance advantage of MSC SIX and EMSC SIX at backbone interlinks indicate the potential of this approach. However, it should be kept in mind that the actual performance in a scenario also depends on other factors such as group size and clustering.

4. **Enhanced MSC performs better than standard MSC.** The main advantage of enhanced MSC are the reduced delays. In scenarios with a small number of hosts (four/eight), enhanced MSC shows the same performance as standard MSC. For large groups however (16 or 20 hosts), enhanced MSC produces significantly lower (10-20ms) average delays. This is the direct result of much more efficient packet forwarding, as can also be seen from the massively reduced percentage of delays in excess of 150ms (1% vs. 6%).

Another difference between standard and enhanced MSC is visible in the backbone usage. In each scenario, enhanced MSC consumes about the same amount of bandwidth as standard MSC. The difference lies in *where* it is consumed: As has been explained in section 9.8, enhanced MSC burdens backbone links with duplicate packets (addressed to different egress routers), but in turn exonerates the access networks by ensuring that they never have to "return" an incoming packet to the backbone network. Depending on the network infrastructure, this feature may be considered an advantage or a disadvantage.

The question is whether the advantage(s) outweigh the additional costs (i.e. complexity). An answer could only be found through further analysis of the router functionality, which unfortunately can't be done with ns-2.

11 Outlook

Due to time constraints and limitations of the network simulation software, not all aspects affecting MSC's performance could be analyzed in this thesis. The increased router complexity introduced by Multicast for Small conferences is such a feature. Ns-2 provides support for the performance analysis of different routing protocols, but an evaluation of router performance is not possible, in particular because the simulation software's internal packet forwarding mechanisms differ from those of a real-world router. Thus, another evaluation approach is required. Ideally, Multicast for Small Conferences should be implemented in an actual router, for example using Linux. Such a router could not only help to determine the (negative) impact of MSC on routing performance, but would also be a first step towards a complete implementation, which in turn could be used for simulations in real networks. Once finished, an MSC implementation would also allow to confirm and refine the results of the simulations performed as part of this thesis.

Another aspect which certainly requires further analysis is the effect of Multicast for Small Conferences (or similar approaches) on the routing table size. Such a study should probably analyse the structure of the routing tables of backbone routers (e.g. the amount of multicast routing entries) as well as the popularity of small group applications. By estimating the amount of IP Multicast sessions replacable by more efficient solutions it should be possible to determine the impact of MSC on the routing tables.

The integration of MSC and IP Multicast is another matter requiring further analysis. Multicast for Small Conferences has primarily been designed for use in the backbone networks, where it exonerates the routers by removing the need to maintain a routing table entry for each and every multicast group in use. While it is possible to have an all-MSC multicast (with all end systems capable of MSC), other configurations could be useful as well. For example, MSC gateways (described briefly in section 3.2.1) might be used at the edges of the backbone networks. Using such devices, native multicast mechanisms can remain in use in the access networks, allowing for the integration of non-MSC-capable end systems into MSC sessions, while retaining the major advantage of the new concept. As mentioned at the end of section 7.1.3, doing a performance simulation of such a scenario is quite complex, particularly because a simulation topology much more complex than the one used in this thesis is required.

Similarly, it might be interesting to do research on the possible combination of Multicast for Small Conferences with end system multicast approaches.

Glossary

- Bayeux** An application-level multicast concept based on the Tapestry routing protocol.
- CAN (Content-Addressable Network)** An overlay network which can also be used for application-level multicasting.
- DCM (Distributed Core Multicast)** A multicast routing protocol for use within large single domain network with a large number of multicast groups with a small number of receivers.
- EMSC (Enhanced MSC)** An improved version of MSC, relying on additional routing information.
- EXPRESS (Explicitly Requested Single-Source Multicast)** A concept aimed at improving IP Multicast by introducing channels.
- IP (Internet Protocol)** Defines network layer packets and procedures used to move datagrams from host to host; currently, Version 4 (IPv4) is standard.
- IPv6 (Internet Protocol Version 6)** The “next generation” internet protocol, aimed at replacing IPv4.
- IP Multicast** A mechanism in the IP protocol which allows efficient (in terms of bandwidth consumption) one-to-many and many-to-many transmissions.
- Link Stress** The number of packets with identical payload sent over a certain link.
- MSC (Multicast for Small Conferences)** A novel approach for resolving scalability problems of IP multicast.
- Naive Unicast** A method of one-to-many communication where the source maintains a unicast connection to each receiver.
- Nam** A network data visualization tool; part of the ns-2 distribution.
- Narada** A multicast concept which uses an overlay network formed by the group members to efficiently distribute the data.
- Native Multicast** *see IP Multicast*
- NRU (Normalized Resource Usage)** The link usage for the transmission of a certain amount of data between two hosts using an alternative approach (e.g. MSC) divided by the bandwidth consumption of the same transmission when native multicast is used.
- Ns-2** A network simulation software package.

OSPF (Open Shortest Path First) A router protocol used within Autonomous Systems (AS); using OSPF, a host that detects a change in the network relays that information to the other hosts in the network, so that all will have the same routing table information.

PIM-DM (Protocol Independent Multicast - Dense Mode) A multicast routing protocol specially designed for situations where multicast groups are thinly distributed over a large region.

PIM-SM (Protocol Independent Multicast - Sparse Mode) A multicast routing protocol which uses flood and prune mechanisms for building multicast trees.

RDP (Relative Delay Penalty) The ratio of the MSC delay between two hosts to the IP Multicast delay between them: $\frac{MSC\ delay}{IP\ Multicast\ delay}$

REUNITE (Recursive Unicast Tree) A multicast protocol based on unicast routing only.

RTP (Real-Time Transport Protocol) RTP provides end-to-end network transport functions for applications transmitting real-time data such as audio or video.

Scattercast A model for application-level multicast.

UDP (User Datagramm Protocol) A connection-less transport layer protocol.

Xcast (Explicit Multicast) A multicast scheme for supporting small and sparse multicast groups.

Bibliography

- [1] Abilene website.
<http://www.internet2.edu/abilene/>.
- [2] Florian Baumgartner.
Quality of Service Support by Active Networks.
PhD thesis, University of Bern, February 2002.
- [3] Ljubica Blazevic and Jean-Yves Le Boudec.
Distributed Core Multicast (DCM): A Multicast Routing Protocol for Many Groups with Few Receivers.
In *Networked Group Communication*, pages 108–125, 1999.
- [4] R. Boivie and N. Feldman.
Small Group Multicast, Internet Draft, July 2000.
- [5] R. Boivie, N. Feldman, and Ch. Metz.
Small Group Multicast: A New Solution for Multicasting on the Internet.
Internet Computing, 4(3), May/June 2000.
- [6] Torsten Braun.
Multicast for Small Conferences.
Technical Report IAM-00-008, Institute of Computer Science and Applied Mathematics, University of Berne, Switzerland, July 2000.
- [7] Yatin Chawathe, Steven McCanne, and Eric Brewer.
An Architecture for Internet Content Distribution as an Infrastructure Service.
Technical report, University of Berkeley, 2000.
- [8] Jae Chung and Mark Claypool.
NS by Example.
Available online from <http://nile.wpi.edu/NS/>.
- [9] Dante website.
<http://www.dante.net>.
- [10] S. Deering.
Host Extensions for IP Multicasting, RFC 1112, August 1989.
- [11] DFN/G-WiN website.
<http://www.dfn.de>.
- [12] Garr website.
<http://www.garr.it>.
- [13] Géant website.
<http://www.dante.net/geant/>.

Bibliography

- [14] Marc Greis' tutorial.
Available online from <http://www.isi.edu/nsnam/ns/tutorial/>.
- [15] Hugh W. Holbrook and David R. Cheriton.
IP Multicast Channels: EXPRESS Support for Large-scale Single-source Applications.
In *Proceedings of ACM SIGCOMM*. Department of Computer Science, Stanford University, September 1999.
- [16] Yang hua Chu, Sanjay G. Rao, and Hui Zhang.
A Case for End System Multicast.
In *Proceedings of ACM SIGMETRICS*. Carnegie Mellon University, 2000.
- [17] Internet2 website.
<http://www.internet2.edu>.
- [18] How IP Multicast Works.
Available online from <http://www.ipmulticast.com>.
- [19] Ns-2 website.
<http://www.isi.edu/nsnam/>.
- [20] The ns Manual.
Available online from <http://www.isi.edu/nsnam/ns/>.
- [21] Opnet website.
<http://www.opnet.com>.
- [22] J. Postel.
User Datagram Protocol, RFC 768, August 1980.
- [23] S. Ratnasamy, P. Francis, M. Handley, R. Karp, and S. Shenker.
A Scalable Content-Addressable Network.
In *Proceedings of ACM SIGCOMM*, August 2001.
- [24] Sylvia Ratnasamy, Mark Handley, Richard Karp, and Scott Shenker.
Application-level Multicast using Content-Addressable Networks.
In *Proceedings of ACM SIGCOMM*, August 2001.
- [25] H. Schulzrinne, S. Casner, R. Frederick, and V. Jacobson.
RTP: A Transport Protocol for Real-time Applications, RFC 1889, January 1996.
- [26] S.Deering and R.Hinden.
Internet Protocol, Version 6 (IPv6) Specification, RFC 2460, December 1998.
- [27] Ion Stoica, T. S. Eugene, and Hui Zhang.
REUNITE: A Recursive Unicast Approach to Multicast.
In *Proceedings of IEEE Infocom '00*. Carnegie Mellon University, March 2000.
- [28] Switch website.
<http://www.switch.ch>.
- [29] Explicit Multicast website.
<http://www.watersprings.org/links/xcast/>.
- [30] Explicit Multicast website (Alcatel).
<http://www.alcatel.com/xcast/>.
- [31] Explicit Multicast (Xcast) Basic Specification, Internet Draft.
Available online from <http://www.ietf.org/internet-drafts/>, June 2002.

Bibliography

- [32] Beichuan Zhang, Sugih Jamin, and Lixia Zhang.
Host Multicast: A Framework for Delivering Multicast to End Users.
- [33] B. Y. Zhao, J. D. Kubiawicz, and A. D. Joseph.
Tapestry: An Infrastructure for Fault-tolerant Wide-area Location and Routing.
Technical Report UCB/CSD-01-1141, University of California at Berkeley, Computer Science Division, April 2001.
- [34] Shelley Q. Zhuang, Ben Y. Zhao, Anthony D. Joseph, Randy H. Katz, and John D. Kubiawicz.
Bayeux: An Architecture for Scalable and Fault-tolerant Wide-area Data Dissemination.
In *Proceedings of NOSSDAV*. Computer Science Division, University of California at Berkeley, 2001.